



# SunSky®

Corrugated  
Polycarbonate  
Skylight and  
Side Light Panels  
for Advanced  
Metal Buildings



Creating Solutions



High performance products like these rely on polycarbonate glazing to resist high impact, high winds, hailstorms, fire, temperature extremes, and long-term exposure to ultraviolet light...



the same conditions that skylights and side lights must resist.



## CONTENTS

Description	3
Climatic Performance	4
Radiation Filtering	4
Thermal Insulation	4
Weathering	4
Weathering Properties	5
Uniform Load	6
Uplift	7
Hail Velocity	7
Typical Physical Properties	8
Soft White	9
Chemical Resistance	10

**NEW**  
**SOFT WHITE**  
 with 100% Diffusion  
 SUNSKY CORRUGATED  
 POLYCARBONATE  
 SEE PAGE 9



**SunSky**  
 CORRUGATED POLYCARBONATE

## Description

For skylight and sidelite applications, SunSky® corrugated polycarbonate panels offer multiple advantages over traditional fiberglass corrugated panels: up to 20 times greater impact resistance, the highest light transmission rates, the lowest yellowing index, the highest load rating, and the highest resistance to wind uplift... outstanding properties

confirmed in accredited laboratory testing and in installations worldwide since 1984.

The panels are also available in custom profiles to match any corrugated metal roofing system, and in custom thickness to customer specifications (minimums apply).

### SunSky Features:

- Virtually unbreakable
- Self extinguishing
- Retains optical clarity over time
- Wide temperature range (-40°F to 210°F)
- Easily and safely Installed
- 10-Year warranty
- Hail and wind resistant
- 100% UV protection

### Stock Profiles (Typically Readily Available)

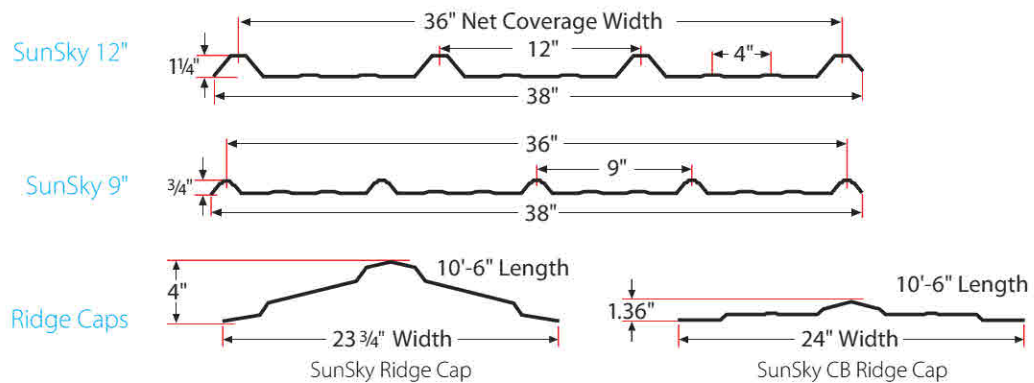

### Specialty Profiles\* (Minimum Order Quantity & Lead Time Required)

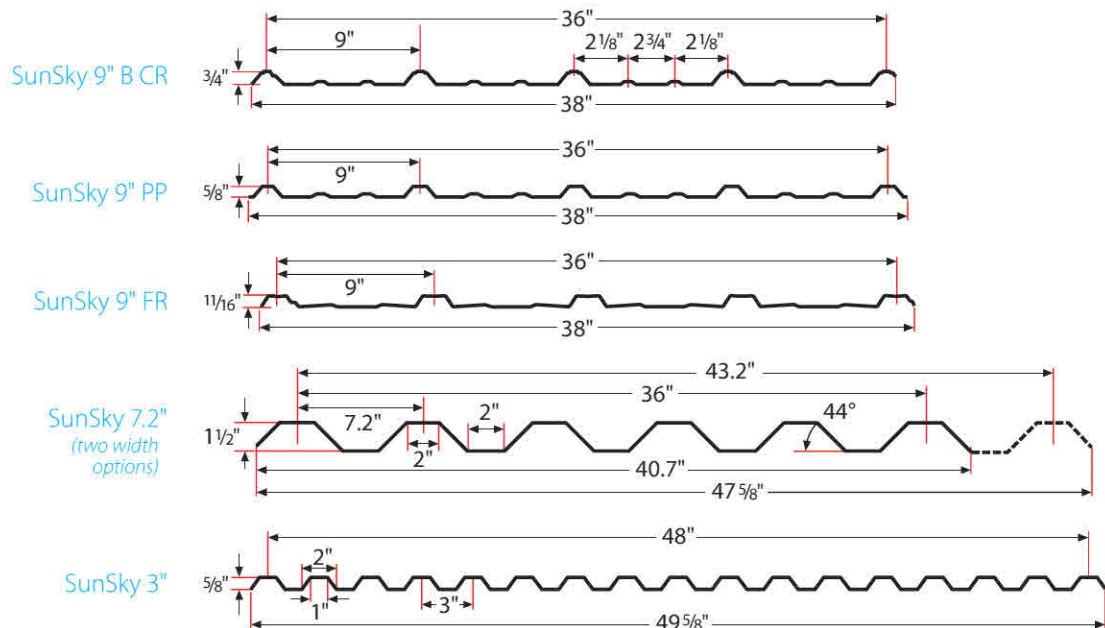

Profile Description	Available Color/Tint	Thickness (in/mm)	Length
SunSky 9" all types, and 12"	Clear, Soft White and Opal White	0.032 / 0.80	8', 10', 10'-6", 11', 12', 16', 24'
SunSky 12"	Clear, Soft White and Opal White	0.039 / 1.00	8', 10', 10'-6", 11', 12', 16', 24'
SunSky 7.2"	Clear, Soft White and Opal White	0.039/ 1.00	Special Order
SunSky Ridge Cap	Clear, Soft White and Opal White	0.039/1.00	10'-6"

Custom lengths available. Lead time depends on production schedule and order quantity.

\* Specialty profiles are typically not in stock, but can be produced provided minimum order requirements, lead time, and pricing considerations are met.

## Radiation Filtering

SunSky Panels transmit radiation selectively. They form a complete shield against harmful ultraviolet rays which may scorch crops, while admitting most of the visible light, essential to crop health and photosynthesis. By completely blocking the far infrared rays, SunSky prevents heat loss at night. SunSky blocks both UV-A and UV-B.

## Climatic Performance

SunSky Panels perform flawlessly under extremely harsh climatic conditions. Service temperature range -40° to 210° F, enabling unlimited use throughout the world.

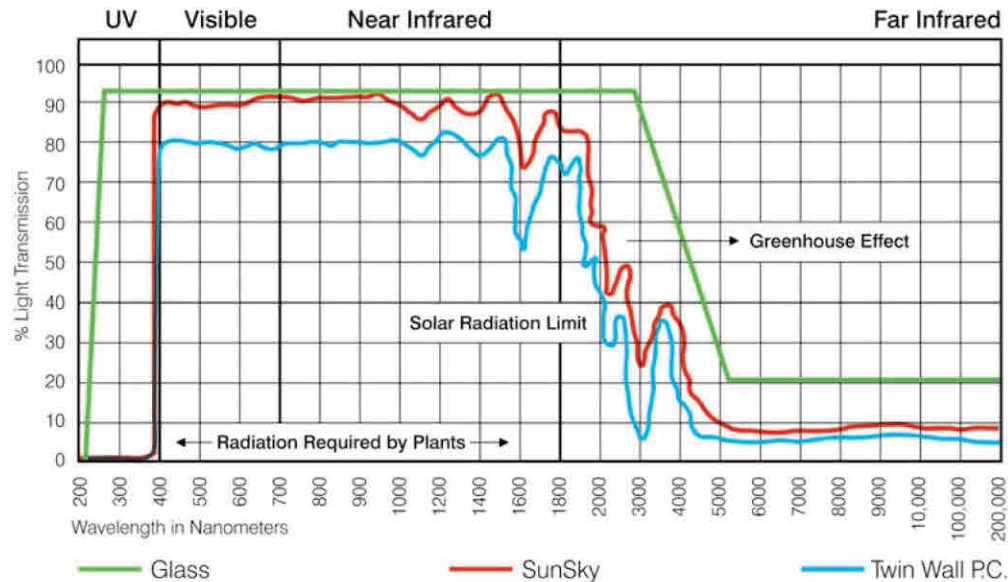

## Thermal Insulation

SunSky's heat conductivity is lower than fiberglass (FRP) sheets. These features facilitate considerable heating cost cuts, in comparison with fiberglass.

## Weathering

Due to its coextruded built-in UV blocking and protecting layer, SunSky maintains its light transmission and physical properties and does not yellow: Arizona tests and accelerated QUV tests indicate a significant advantage of SunSky over competitive sheets such as twin wall polycarbonate and fiberglass.

### QUV 1000 HOUR YELLOWING TEST

(roughly equivalent to 10 year actual exposure)



SunSky Corrugated Polycarbonate Panels exhibit significantly greater resistance to yellowing than fiberglass panels.

# Weathering Properties

SunSky Corrugated Polycarbonate Panels demonstrate greater resistance to yellowing, and transmit more light, than fiberglass panels. The results from QUV testing depicted below demonstrate the superior performance of SunSky compared to competing products. 100 hours of QUV exposure is roughly equivalent to 1 year of actual outdoor exposure in Arizona.

Clear Materials	Exp. Hrs.	% LT Light Transmission	Δ% LT Light Transmission	YI Yellowing Index	ΔYI Yellowing Index
SUNSKY Polycarbonate	0	91.2	0	1.26	0
	250	90.7	-0.5	4.27	3.01
	500	89.7	-1.5	6.69	5.43
	750	90.9	-0.3	3.78	2.52
	1000	91.2	0	3.70	2.44
Brand A FRP 5 oz.	0	90.3	0	9.89	0
	250	88.0	-2.3	18.25	8.36
	500	83.7	-6.6	24.43	14.54
	750	86.4	-3.9	22.43	12.54
	1000	83.3	-7.0	27.88	17.99
Brand A FRP 8 oz.	0	85.8	0	15.10	0
	250	75.4	-10.4	31.98	16.88
	500	82.7	-3.1	27.42	13.32
	750	79.3	-6.3	29.89	14.79
	1000	76.6	-9.2	30.45	15.35
Brand B FRP 5 oz.	0	90.5	0	7.17	0
	250	85.5	-5.0	14.83	7.66
	500	84.0	-6.5	16.74	9.57
	750	81.5	-9.0	20.68	13.51
	1000	83.8	-6.7	19.47	12.30
Brand B FRP 8 oz.	0	83.5	0	12.61	0
	250	81.7	-1.8	22.56	9.95
	500	79.2	-4.3	19.61	7.00
	750	78.2	-5.3	21.62	9.01
	1000	80.1	-3.4	26.97	14.36

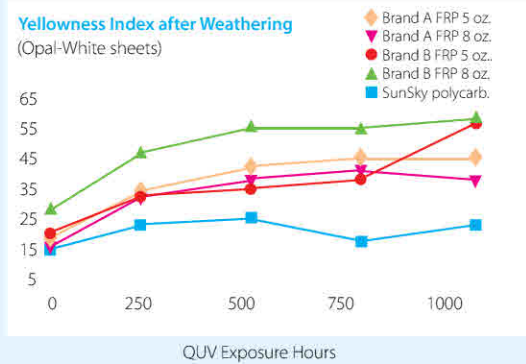
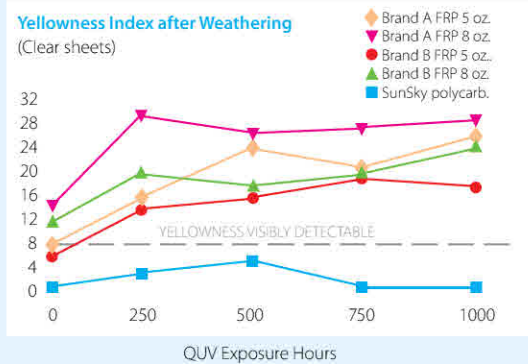

Note: Each 100 hours of weathering test roughly equivalent to one year actual weathering.

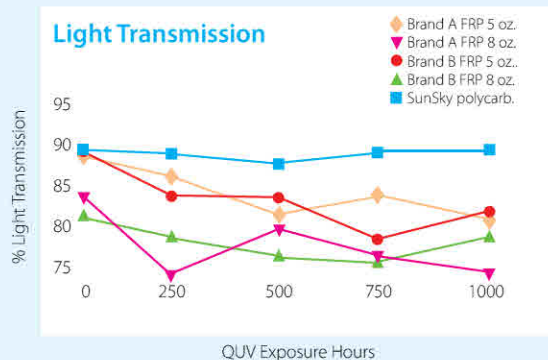

Note: Each 100 hours of weathering test roughly equivalent to one year actual weathering.

# Uniform Load

SunSky Corrugated Polycarbonate Panels had no mechanical failures or cracks at the end of any test to measure ultimate load when tested to "ICBO Evaluation Service Acceptance Criteria, AC 16 Plastic Skylights" (UL recognized file number 18450).

**Note:** The tables below are provided only as a guideline. Information was obtained from tests using SunSky polycarbonate panels as roofing and siding. To avoid premature failure, all proposed spans should be tested in actual tests. In addition, a licensed engineer or architect must verify the application.

## Multi-Panel Runs for roofing and siding

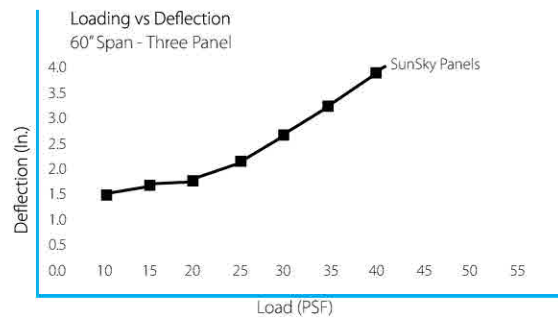
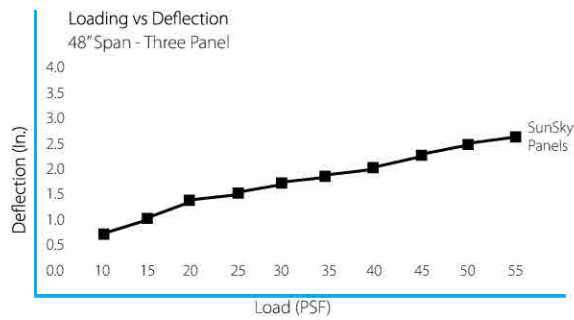
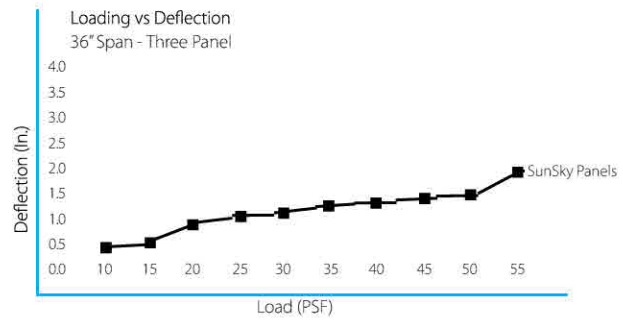

## Single-Panel Runs for roofing and siding

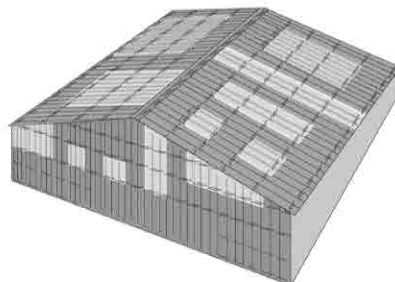
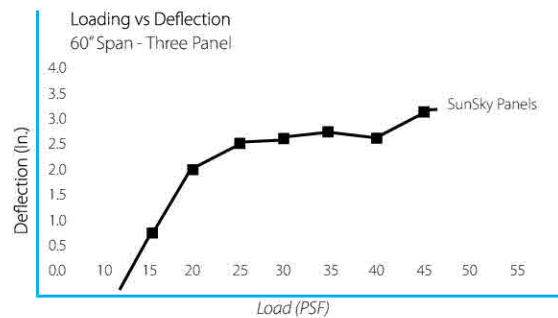

For detailed Installation Instructions  
Contact Palram Americas and request:

## SunSky Installation Guide Booklet

## Uplift

SunSky corrugated polycarbonate panels meet Uplift Test Criteria specified in UL 580 Test for Uplift Resistance of Roof Assemblies (UL Class 90).

### Test Description

**Roof Covering:** Corrugated polycarbonate roof panels with 9-inch spaced corrugations. The tested material is 0.032" thick x 38" wide and 12 feet long.

**Fastener:** #12-14 x 1 1/4" Type 2 Structural Drilling Fastener, carbon steel, zinc plate with 3/4" O.D. heavy EPDM/ galvanized washer.

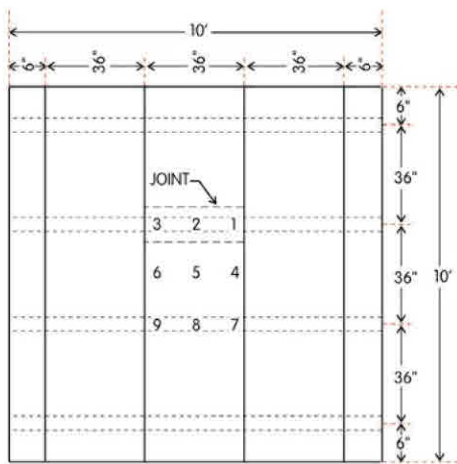

### Test Results

A buckled hip was visible during the test. The fasteners were in place and no cracks or breaks were found in the SunSky panels. The test assembly withstood all phases of test for Class 90. The roof assembly described in this report met the uplift test criteria specified in UL 580 - Test for Uplift Resistance of Roof Assemblies.

**Note:** The buckled hip returned to its original shape after testing with no panel damage or permanent deformation.



## Hail Velocity

SunSky Corrugated Polycarbonate Panels demonstrate greater resistance to high-velocity impact (hail simulation test) than fiberglass panels.

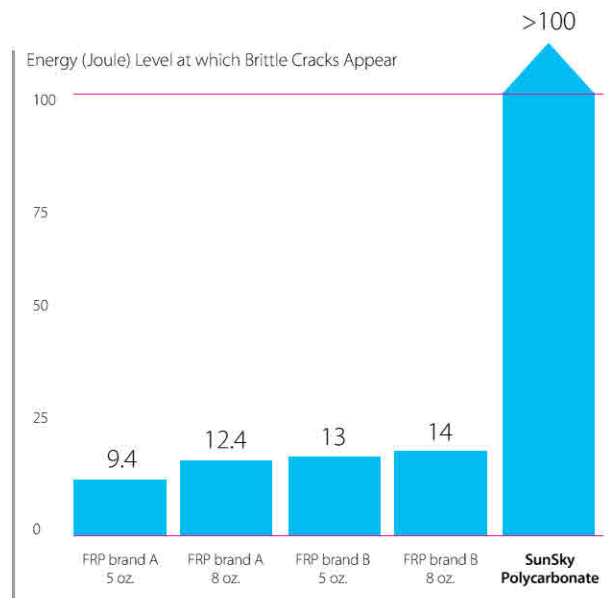
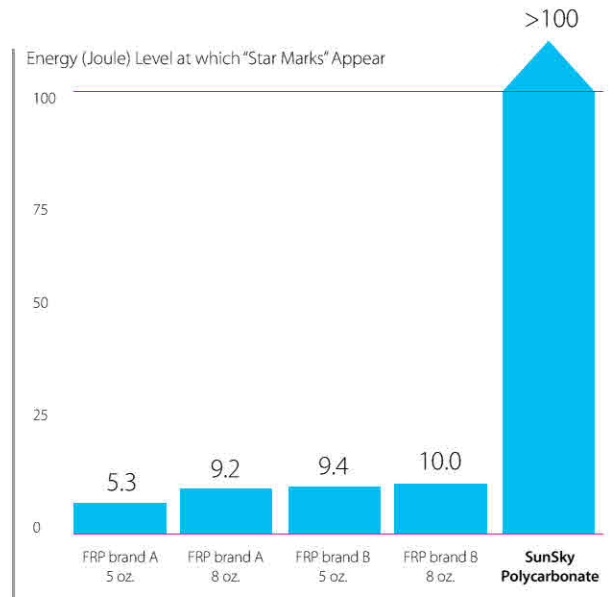

**Note:** SunSky Corrugated Polycarbonate Panels remain ductile with no cracks or breaks at the maximum energy level at which this test is conducted: 100 Joules (1J=0.737 ft·lb)

### Approvals

- Miami - Dade County Product Control\* Approved Acceptance No. NOA 00-1226.02  
\*Highest U.S. Code Standards
- FBC Approval: Pending (Call for updated info)
- City of Los Angeles - Research Report RR25298

# Typical Physical Properties

	Property	Test Method	Value
Physical	Specific gravity	ASTM D-792	1.2
	Density (lb./ft. <sup>3</sup> )	ASTM D-1505	75
	Water Absorption, 24 hr. @ 73°F (%)	ASTM D-570	0.15
Mechanical	Tensile strength at yield, 0.4 in./min. (psi)	ASTM D-638	9,000
	Tensile strength at break, 0.4 in./min. (psi)	ASTM D-638	9,500
	Elongation at yield, 0.4 in./min. (%)	ASTM D-638	6
	Elongation at break, 0.4 in./min. (%)	ASTM D-638	>80
	Tensile Modulus, 0.04 in./min. (psi)	ASTM D-638	340,000
	Flexural Modulus 0.04 in./min. (psi)	ASTM D-790	380,000
	Flexural strength at yield, 0.04 in./min. (psi)	ASTM D-790	14,500
	Izod impact strength, notched (73°F), ft./lb./in.	ASTM D-256	1.5
	Impact falling weight, (ft.lb./in.)	ISO 6603/1 <sup>a</sup>	37
	Rockwell hardness, R scale	ASTM D-785	118
	OSHA point-29	CFR 1910.23 (e) (8) <sup>a</sup>	Passed 200 lb.
	Uplift	UL 580 <sup>b</sup>	Passed UL 90
	Thermal	Optimal Temperature Range °F -40 to +210	
U-Factor Summer		C-236	1.04
U-Factor Winter		C-236	1.14
Heat Deflection Temperature °F Load: 264 (psi)		ASTM D-648	275
Coefficient of Linear Thermal Expansion 10 <sup>-5</sup> /°F		ASTM D-696	3.6
Thermal Conductivity BTU in./(hr. ft. <sup>2</sup> °F)		ASTM C-177	1.46
Flammability	Self-Ignition (°F)	ASTM D-1929	977
	Burning Extent	ASTM D-635	CC2 (<2.5 in.)
	Smoke Density (%)	ASTM D-2843	51
	Smoke Developed	UL 723 (E-84) <sup>a</sup>	47.0
	Flame Spread	UL 723 (E-84) <sup>a</sup>	4.7 (Class A)
	Melt Point (°F)	ASTM D-1519-95	420
Electrical	Dielectric Constant:		
	1kHz	ASTM D-150	2.6
	1MHz	ASTM D-150	2.4
	Dissipation Factor:		
	1kHz	ASTM D-150	0.005
	1MHz	ASTM D-150	0.02
	Dielectric Strength Short:		
	500 V/s (V/mil.)	ASTM D-149	520
	Surface Resistance:		
	Ketley (Ohm)	ASTM D-257	4.1 x 10 <sup>15</sup>
Volume Resistance:			
Ketley (Ohm-cm)	ASTM D-257	1.7 x 10 <sup>17</sup>	
Optical	Visible light transmittance (%)		
	Clear	ASTM D-1003	90
	Soft White	ASTM D-1003	85
	Opal White	ASTM D-1003	45
	Haze/Diffusion (%)		
	Clear	ASTM D-1003	<1
	Soft White	ASTM D-1003	100
	Opal White	ASTM D-1003	100
	Yellowness Index)		
	Clear	ASTM D-1003	<1
	Soft White	ASTM D-1003	<3
	Opal White	ASTM D-1003	<1
	Shading coefficient		
	Clear	ASTM E424-71	1
	Soft White	ASTM E424-71	.96
	Opal White	ASTM E424-71	.56

<sup>a</sup> All the results depicted in this table were obtained by following the indicated ASTM method except where another method is indicated by the appearance of this symbol (<sup>b</sup>)



## Increase Productivity while Reducing Energy Costs with... **SunSky Soft White**

Let the beauty of natural sunlight in, without the harshness! Translucent SunSky Soft White panels allow 85% light transmission, for light that fills the room without unpleasant glare or the stark contrast of hard-edged shadows.

SunSky Soft White panels provide diffused, omni-directional ambient light, creating a more comfortable, worker-friendly environment for enhanced productivity. They're perfect for skylights, ridge lighting and vertical side lights all of which can decrease energy costs by reducing the need for daytime electric lighting. And the soft white coloration is co-extruded with the polycarbonate, so it will never peel or wear off.

SunSky Soft White is available in all of our standard or custom profiles.

### All of the features of our **SunSky Clear panels...** **Without the Glare!**

- 85% Light Transmission vs. 90% for Clear
- Soft/Diffused Light for a More Productive Environment
- Virtually Unbreakable • Blocks 100% of Harmful UV Rays
- Service Temperature Range for All Climates
- Light Weight • Easy to Install



Clear skylight panels can create a harsh indoor lighting environment, with glaring sunlight in some areas and stark shadows in others.



SunSky Soft White panels fill the room with natural light, for better all-around visibility and a more productive work area.

## Need Insulated side lights? Consider SUNLITE Multi-Wall Polycarbonate.



If you have an application that requires insulated side lights, consider SUNLITE® multi-wall polycarbonate. Because SUNLITE has multiple air spaces between the inner and outer surfaces, it provides excellent insulation. To learn more about equipping your building with SUNLITE, contact your Palram Distributor. Ask for our Applications Idea Sheet (form #1201).



### Features at a Glance

- Energy saving design
- Rigid and light weight
- Highly impact resistant
- Up to 80% light transmission for maximum light
- Virtually unbreakable
- 10-year warranty
- Easy to install
- 100% UV protection
- 200 times stronger than glass

# Chemical Resistance

The mechanism of chemical attack on polycarbonate sheets differs significantly from the mechanism of corrosion of metals. Corrosion of metals results in a gradual loss of surface material as a result of electrolytic action by the relevant chemicals. In the cases where chemical attack on polycarbonate sheet occurs, all or a portion of a range of effects can be observed. Ethylene chloride, chloroform, tetrachloroethane, m-cresol, pyridine and other chemicals can cause partial dissolution of polycarbonate. Swelling agents include benzene, chlorobenzene, tetralin, acetone, ethyl acetate, acetonitrile and carbon tetrachloride. Additional effects include color change and/or whitening. These effects may not always lead to product failure, especially for non-loaded sheets. Nevertheless, the level of measured mechanical properties will be reduced. The most critical effect of chemical attack is stress cracking or crazing, which may range in size from being visible to the naked eye to being only visible under a microscope. Stress cracks will always result in sheet failure which will emanate from areas of greatest stress (screws, fixings, bends, etc.)

Polycarbonate sheets are generally not recommended for use with acetone, ketones, ethers, and aromatic and chlorinated hydrocarbons in addition to aqueous or alcoholic alkaline solutions, ammonia gas and its solutions and amines.

Polycarbonate is resistant to mineral acids, many organic acids, oxidizing and reducing agents, neutral and acid salt solutions, many greases, waxes and

oils, saturated, aliphatic and cycloaliphatic hydrocarbons and alcohols, with the exception of methyl alcohol. The resistance of polycarbonate to water may be described as good up to approximately 60°C. At higher temperatures, degradation occurs, the extent of which depends on time and temperature. Polycarbonate should therefore not be exposed for long periods of time to hot water. However, brief contact with hot water has no effect. For example, polycarbonate tableware can be washed over 1000 times in a dishwasher with no adverse effects.

The table that appears below lists the resistance of polycarbonate sheets to a number of commonly encountered chemicals and other corrosive media at room temperature (Information on chemical resistance at higher temperatures will be supplied upon request). Where the chemical resistance varies with concentration, the results of tests at different concentrations is presented. The information on chemical resistance is based on our research and experience (information on compatible adhesives can be found on page 18 of the SunSky Installation Guide), and serves as a basis for recommendation. Palram Americas does not guarantee chemical resistance unless specific separate, documentation is supplied.

For chemicals and corrosive media not depicted in the list, please contact your Palram Americas representative.

## Chart Key:

R = Resistant

LR = Limited Resistance

N = No Resistance

Chemical	Concentration %*	Resistance	Chemical	Concentration %*	Resistance	Chemical	Concentration %*	Resistance
Acetaldehyde		N	Benzyl Alcohol		N	Cloves		N
Acetic Acid	10	R	Betadine		R	Coal Gas		R
Acetic Acid	25 (concentrated)	LR (N)	Bleach (Dorox)		R	Coca Cola		LR
Acetone		N	Blood and Blood Plasma		R	Cocoa		LR
Acetylene		R	Borax		R	Cod Liver Oil		R
Acrylonitrile		N	Boric Acid		R	Coffee		LR
Ajax Detergent		R	Brake Fluid		N	Cooking Oil		R
Allspice		N	Bromine		N	Copper Sulfate	Saturated	R
Allyl Alcohol		LR	Bromobenzene		N	Cresol		N
Alum (Aluminum Ammonium Sulfate)		R	Butane		R	Cupric Chloride	Saturated	R
Aluminum Chloride	Saturated	R	Butter		R	Cuprous Chloride	Saturated	R
Aluminum Oxalate		R	Butyl Acetate		N	Cyclohexane		R
Aluminum Sulfate	Saturated	R	Butyl Alcohol (Butanol)		R	Cyclohexanol		LR
Ammonia (Gas)		N	Butylene Glycol		R	Cyclohexanone		N
Ammonia (Aqueous)		N	Butyric Acid		N	DDT		R
Ammonium Carbonate		LR	Calcium Chloride	Saturated	R	Dekalin		R
Ammonium Chloride		R	Calcium Hypochlorite		R	Detergent (most)		LR or R
Ammonium Fluoride		N	Calcium Nitrate		R	Developing Solutions		N or LR
Ammonium Hydroxide		N	Calcium Soap Fat		R	Diamyl Phthalate		N
Ammonium Nitrate		R	Camphor Oil		N	Diesel Fuel		R
Ammonium Sulfate	Saturated	R	Carbolic Acid		N	Diethyl Ether (Ethyl Ether)		N
Ammonium Sulfide		N	Carbon Bisulfite		R	Dimethyl Formaldehyde (DMF)		N
Amyl Acetate		N	Carbon Dioxide Gas (Moist)		R	Dimethyl Sulfoxide (DMSO)		N
Amyl Alcohol		LR	Carbon Disulfide		N	Dinonyl Phthalate (plasticizer)		LR
Aniline		N	Carbon Monoxide		R	Doctyl Phthalate (plasticizer)		LR
Antimony Trichloride	Saturated	R	Carbon Tetrachloride		N	Dioxane		N
Aqua Regia (3 parts HCl:1 part HNO <sub>3</sub> )		LR	Castor Oil		R	Diphyl 5,3		LR
Arsenic Acid	20	R	Catsup (Ketchup)		R	Ethanol (Ethyl Alcohol) and Water	96	R
Automatic Switch Grease		R	Caustic Potash (Potassium Hydroxide)		N	Ethanol (Ethyl Alcohol)	Pure	LR
Automotive Waxes		LR	Caustic Soda (Sodium Hydroxide)		N	Ethyl Amine		N
Baby Lotion		R	Chlorine Gas (Dry)		LR	Ethyl Acetate		N
Bacon Fat		R	Chlorine Gas (Wet)		N	Ethyl Bromide		N
Barium Chloride		R	Chlorobenzene		N	Ethylene Chloride		N
Battery Acid		R	Chloroform		N	Ethylene Chlorohydrin		N
Beer		R	Chocolate		R	Ethylene Dichloride		N
Beet Syrup		R	Chrome Alum	Saturated	R	Ethylene Glycol (Antifreeze)		LR
Benzaldehyde		N	Chromic Acid	20	R	Ferric Chloride	Saturated	R
Benzene		N	Cinnamon		R	Ferrous Sulfate		R
Benzoic Acid		N	Citric Acid	10	R	Fish and Fish Oils		R

\*concentration of aqueous solution except where noted

The chemical resistance information in this table is based on our research and experience and may be considered solely as a basis for recommendation, but not as a guarantee, unless specifically furnished as such by Palram Americas.

Chemical	Concentration %*	Resistance	Chemical	Concentration %*	Resistance	Chemical	Concentration %*	Resistance
Floor Polish		R	Nitric Acid	20	R	Sodium Carbonate	Saturated	R
Formalin	10%	R	Nitrobenzene		N	Sodium Chlorate		R
Formic Acid	10% (30%)	R (LR)	Nitropropane		N	Sodium Chloride	Saturated	R
Freon TF		R	Nitrous Oxide		N	Sodium Chromate		R
Freon (all others)		N	Nutmeg		N	Sodium Hydroxide		N
Fruit Juices and Pulp		R	Oleic Acid		R	Sodium Hypochlorite	5% Chlorine	R
Gasoline		N	Onions		R	Sodium Nitrate		N
Gear Oil		R	Oxalic Acid	10	R	Sodium Sulfate	Saturated	R
Glazers Putty		R	Oxygen		R	Sodium Sulfide		N
Glucose		R	Ozone		N	Sodium Thiosulfate		R
Glycerine		R	Paprika		R	Spindle Oil		R
Glycerol		R	Paraffin		R	Stannous Chloride		R
Glycols		R	Pentane		R	Starch		R
Glutaraldehyde	50%	R	Pepper		R	Styrene		N
Grease, Automotive (Most)		R	Perchloric Acid	10 (concentrated)	R (LR)	Sugar	Saturated	R
Heptane		R	Perchloroethylene		N	Sulfur Dioxide (Gas)		R
Hexane		R	Petroleum		LR	Sulfuric Acid	<50 (50<70)	R (LR)
Hydrazine		N	Petroleum Ether		LR	Sulfurous Acid	10	N
Hydrochloric Acid	20 (Concentrated)	R (N)	Petroleum Oil (Refined)		R	Sulfuryl Chloride		N
Hydrofluoric Acid	20	R	Phenol		N	Tapping Oil		R
Hydrogen Peroxide	30	R	Phosphoric Acid	10	R	Tartaric Acid	30	R
Hydrogen Sulfide		R	Phosphorous Oxychloride		R	Tear Gas (Chloracetophenone)		LR
Iodine (aqueous solution)	5	R	Phosphorous Pentoxide	25	LR	Terpineol		N
Iodine		N	Phosphorous Trichloride		N	Tetrahydrofuran		N
Inks (Most)		R	Polyethylene		R	Tetralin		N
Isoamyl Alcohol		LR	Polyethylene Glycol		R	Thiophene		N
Isopropyl Alcohol		R	Potassium Acetate		LR	Thyme		R
Kerosene		N	Potassium Aluminum Alum (Sulfate)	Saturated	R	Titanium Tetrachloride		R
Lactic Acid	20	R	Potassium Bichromate		R	Tobacco		R
Lacquers and Thinners		N	Potassium Bromate		R	Toluene		N
Laundry Detergents (Most)		LR or R	Potassium Bromide		R	Transformer Oils		R
Ligroin (Hydrocarbon Mixture)		R	Potassium Chloride	Saturated	R	Transmission Fluid		R
Lime Solution (2%) or paste		R	Potassium Cyanide		N	Trichloroacetic Acid	20	LR
Liquors or Liqueurs		R	Potassium Dichromate	Saturated	R	Trichloroethylamine		N
Linseed Oil		R	Potassium Hydroxide		N	Trichloroethylene		N
Loctite		N	Potassium Metabisulfite	4	R	Trichloroethylphosphate		LR
Lubricating Oils (Most)		LR or R	Potassium Nitrate	Saturated	R	Tricresylphosphite		N
Machine Oils (Most)		R	Potassium Perchlorate	10	R	Trisodium Phosphate		R
Magnesium Chloride	Saturated	R	Potassium Permanganate	10	R	Turpentine		LR
Magnesium Sulfate	Saturated	R	Potassium Persulfate	10	R	Urea		R
Manganese Sulfate	Saturated	R	Potassium Rhodanide	Saturated	R	Vacuum Pump Oil		R
Margarine		R	Potassium Sulfate	Saturated	R	Vanilla		R
Mayonnaise		R	Propane		R	Vanillin		R
Meat		R	Propargyl Alcohol		R	Varnish		N
Mercuric Chloride	Saturated	R	Propionic Acid	20	R	Vaseline		R
Mercury		R	Propionic Acid	Concentrated	N	Vegetable Juices		R
Methane		R	Propyl Alcohol (1-Propanol)		R	Vegetable Oils		R
Methanol (Methyl Alcohol)	Pure	LR	Pyridine		N	Vinegar		R
Methylamine		N	Salad Oil		R	Water (Deminerallized or Sea)		R
Methylcellulose		N	Salt		R	White Spirit		N
Methylene Chloride		N	Silicofluoric Acid	30	R	Wine, Whiskey, Vodka, Rum, Cognac		R
Methyl Ethyl Keton (MEK)		N	Silicone Grease		R	Witch Hazel		R
Methylmethacrylate		N	Silicone Oil		R	Worcester Sauce		R
Milk		R	Silver Nitrate		R	Xylene		N
Mineral Oil		R	Soap (Ivory)		R	Zinc Chloride		R
Motor Oils (Most)		LR or R	Sodium Bicarbonate	Saturated	R	Zinc Oxide		R
Mustard		R	Sodium Bisulfate	Saturated	R	Zinc Stearate		R
Naphtha (Stanisol)		N	Sodium Bisulfite	Saturated	R	Zinc Sulfate		R
Nickel Sulfate		R						

\*concentration of aqueous solution except where noted

The chemical resistance information in this table is based on our research and experience and may be considered solely as a basis for recommendation, but not as a guarantee, unless specifically furnished as such by Palram Americas.

**10-Year Limited Light  
Transmission Warranty\***

It is warranted that for a period of 10 years, SunSky polycarbonate panels shall not lose more than 10% of their light transmitting capability, as a direct and exclusive result of the impact of solar radiation (as measured pursuant to the procedures specified in ASTM D-1003-77).

**10-Year Limited  
Hail Damage Warranty\***

It is warranted that for a period of 10 years, SunSky polycarbonate panels shall not break as a direct and exclusive result of the impact of hail measuring up to one inch diameter in size, and attaining up to 20 meters/sec. in velocity.

*\* This brochure contains statements of general company policy concerning customer satisfaction. There are no warranties which extend beyond that which are specifically set forth in the two limited warranties above.*

Palram Americas reserves the right to change product specifications and/or information contained in this brochure.

**Also Available:**

Suntuf® Corrugated Polycarbonate Panels, SunLite® Multi-Wall Polycarbonate Panels, and Palruf® PVC Panels for residential, agricultural and commercial applications.



For detailed installation instructions visit [www.PalramAmericas.com/SunSky](http://www.PalramAmericas.com/SunSky) and download the SunSky Installation Guide, or call Palram Americas at (800) 999-9459 to request a printed copy.



**PALRAM AMERICAS**  
9735 Commerce Circle  
Kutztown, PA 19530  
Phone: 800-999-9459  
E-mail: [PalramAmericas@Palram.com](mailto:PalramAmericas@Palram.com)

[www.PalramAmericas.com/SunSky](http://www.PalramAmericas.com/SunSky)

Authorized Dealer



Premium Corrugated Polycarbonate Panels

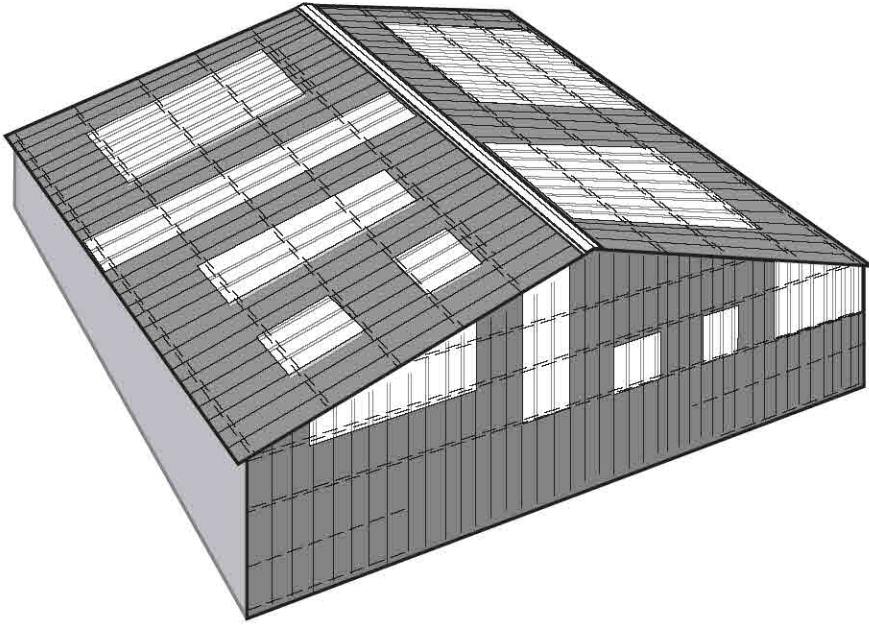

# INSTALLATION GUIDE

# Contents

A. Introduction	3
B. Transportation, Handling & Storage	4
C. Chemical Resistance and Fire Hazard Comments	4
D. Profile Matching	5
E. Sawing, Cutting & Drilling	5
F. Safety Measures	6
G. Panel Orientation	6
H. General Information for Installation	6
I. Maximum Recommended Loads	8
J. Installation Comments	9
K. Fastening & Sealing	10
L. End/Weather Lap Installation	13
M. Options for Installation	15
N. Important Installation Notes	18
O. Expansion & Contraction Table for SunSky	19

## FBC Approved Installation Instructions



To obtain FBC approval, certain installation requirements must be met. The icon shown at left is used within this guide to call out optional FBC-approved installation methods and requirements.

For more information about Florida Building Code requirements, visit the FBC web site at:

**<http://www.floridabuilding.org>**.

Product approval numbers are 11238 (roof decks) and 11240 (structural walls).

## A. Introduction:

SunSky is a high quality light-transmitting, corrugated polycarbonate panel designed to match the profiles of major types of metal roofing and siding panels. It is designed for single or multi-panel skylights or side lights in roofs and walls of metal-clad structures.

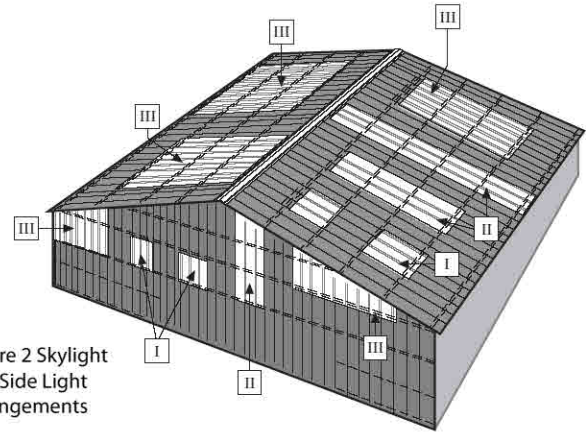
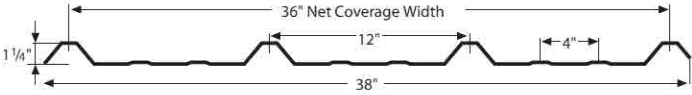
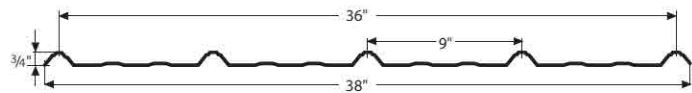
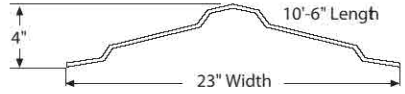
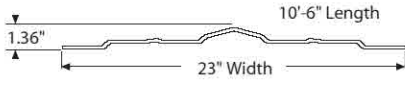
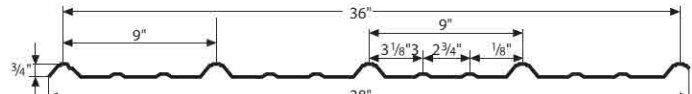
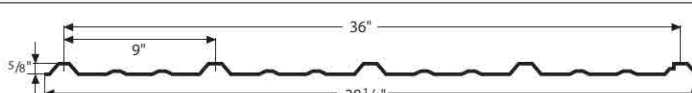
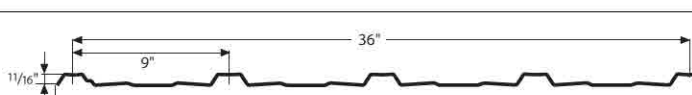

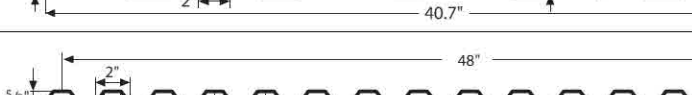

Figure 2 Skylight and Side Light Arrangements

### Various Sunsky Skylight and Side Light Arrangements

- I** Single panel, single span
- II** Single panel run
- III** Multi-panel run

Stock Profiles <i>(Typically readily available)</i>	Basic Dimensions and Profile Illustrations	
<b>SunSky 12"</b>		
<b>SunSky 9"</b>		
<b>Ridge Caps</b>	 <p style="text-align: center;">SunSky Ridge Cap</p>	 <p style="text-align: center;">SunSky CB Ridge Cap</p>

Specialty Profiles* <i>(Min's &amp; Lead Time Required)</i>	Basic Dimensions and Profile Illustrations	
<b>SunSky 9" B CR</b>		
<b>SunSky 9" PP</b>		
<b>SunSky 9" FR</b>		
<b>SunSky 7.2"</b>		
<b>SunSky 7.2"</b>		
<b>SunSky 3"</b>		

\* Note: Specialty profiles are typically not in stock, but can be produced provided minimum order requirements, lead time, and pricing considerations are met.

## B. Transportation, Handling & Storage:

1. Transport and store SunSky panels horizontally on flat, sturdy pallets, equal to or longer than the longest panels. Short panels should be stacked on top of longer ones. The panels should be secured and fastened to the pallet during transportation.

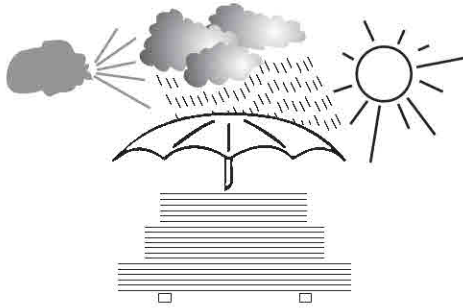

Figure 3

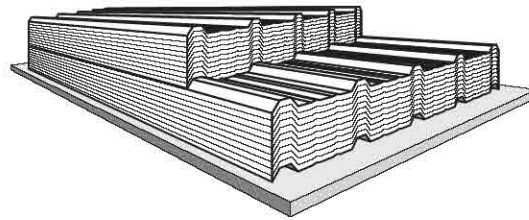

Figure 4

Storage of Panels

2. Store SunSky panels in a cool and shaded place, out of direct sunlight. Avoid covering the stack of panels with dark or heat-absorbing materials or objects, to prevent solar heat buildup.
3. When necessary to store panels outdoors, cover the stack with a white opaque polyethylene sheet, corrugated cardboard or other materials that do not absorb or conduct heat. Be sure that the entire stack is covered.
4. SunSky panels are tough, requiring no special care. However, we recommend some cautionary steps:
  - Avoid stepping on the panel, driving over the panel, or folding the panel when handling and installing.
  - Avoid dragging the panel on the ground, scraping it against the structural elements, or any other sharp or rough objects, to prevent the panel from getting scratched.

## C. Chemical Resistance and Fire Hazard Comments:

1. SunSky panels are resistant to a variety of chemicals and exhibit limited resistance to a second group of chemicals. A third group of chemicals may attack and damage the panel. Degree & severity of damage depends upon chemical type and duration of exposure.

Consult the Chemical Resistance Table that can be downloaded at <http://www.palramamericas.com/Tech>. When in doubt, consult the Palram Technical Support Department or your distributor.

2. SunSky panels will melt at approximately 400°F, generating vent openings for smoke release in the event of fire. Standard operating temperature range for polycarbonate is -40°F to 212°F.



## D. Profile Matching:

1. SunSky profiles were designed to closely match commonly used metal profiles. These profiles, produced by a few major US suppliers, are manufactured with 5 and 4 main corrugations of 9" and 12" spacing respectively, with two minor corrugations in between. Other panels, appearing to be similar, differ in small but important ways and an exact match may be difficult to achieve.
2. SunSky 12" profile will not fit closely over or under the older R-Panel, produced with one central minor corrugation.
3. Slight detail differences such as corrugation height, slant, wave distance etc. will hinder exact matching of such a panel with a SunSky profile. This may lead to insufficient sealing, water leakage and forced installation, putting undue stresses on the SunSky panel while trying to adapt it to an "almost similar" metal profile. **Undue stress may lead to premature failure and void any and all warranties.**
4. A careful comparison will disclose whether a standard SunSky panel matches your metal profile.
5. **Custom SunSky profiles have become easier than ever to produce using Palram's MetalMatch™ Technology.** To determine if a custom SunSky profile can be produced, simply submit a detailed dimensional drawing of the profile, or an actual sample to Palram Americas. Contact your Palram representative for more info, or call Palram at (800) 999-9459.



## E. Sawing, Cutting & Drilling:

1. SunSky panels can be cut or sawed by manual or power tools.  
A bench/table circular saw is best for straight long cuts. For better results cut a few panels together. Portable circular saws are suitable for on-site straight cuts. A jigsaw is used for cutting a limited length of irregular or curved lines.  
Hand tools such as handsaw, metal shears or hand-held cutting knives can be used for localized, limited work.
2. **Sawing** is done with plywood saw blade, installed in reverse direction, with small teeth, or special blades for plastics, spinning at high speeds, with a slow feed rate. Panels should be clamped during sawing, to avoid vibrations. Avoid intersecting cuts. Drill a hole at intersection point, then cut the panel up to the hole.
3. **Drilling** is done using a power drill, with regular high-speed steel bits intended for metal, rotating at about 1,000 RPM. Better results with SunSky are achieved using bits ground to shallower tip angle than for metal. Clamp the drilled panel down to avoid vibrations or movement during operation.
4. Keep the cut area clean. Blow away saw and drill dust with compressed air.

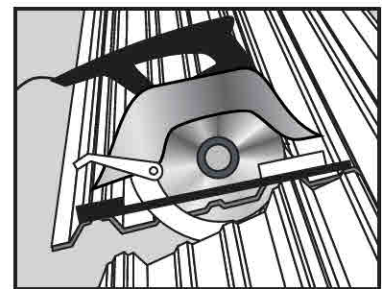

Sawing the panels  
Figure 5

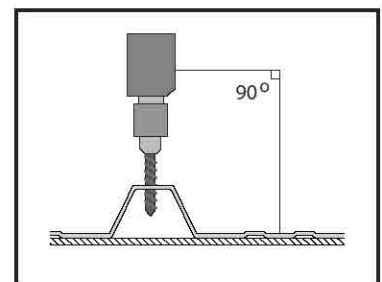

Drilling the panels  
Figure 6

## F. Safety Measures: (during installation and afterwards)

1. Use ladders, crawling boards and other safety equipment required for safe installation. Use all safety measures required according to local safety regulations.
2. Always use appropriate scaffolding to service panels. Scaffolding should provide proper worker safety and ensure proper placement and distribution of weight to avoid damage to panels.

**Do not walk on panels for fear of falling and other severe bodily harm.**

3. Never leave SunSky panels unattended on the roof until all the required fasteners have been appropriately installed or the panels secured to the supporting structure.
4. Always follow local and/or national building and OSHA safety codes.



**Warning! Do not step directly on panels between the purlins! Use scaffolds, ladders, or crawl boards.**

Figure 7

### WARNING!

Fatal falls and serious injuries may result from inadequate guarding and fall protection for work around skylights and roof and floor openings.

## G. Panel Orientation:

1. SunSky's exterior surface is UV resistant, indicated by labeled strips on protected side. **Install the panel with the labeled side out.** The protected side is up when panel edges are both pointing down.
2. Installation Direction: For multi-panel runs, begin installation of SunSky on the side away from wind and rain direction.

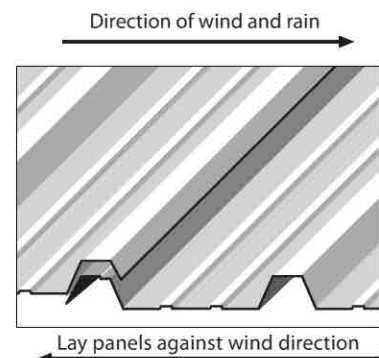

Figure 8

## H. General Information for Installation:

### 1. Roof Pitch:

SunSky performs best when installed at pitch rates of 10 percent (1":10" slope or 5.7°) or more. If installed at a lower pitch, additional sealing should be applied to insure weather resistance. A minimum slope of more than 5% is recommended when installing SunSky.

### 2. Load Rating and Maximum Recommended Distance (Typical profile variations are considered the same):

The depicted distances refer to a single panel, single-span installation on surrounding supportive compatible metal cladding.

#### 2.1 Load Rating Values: Sunsky panels load rating will vary according to the arrangement of panel(s) and existing or designed spans, as mentioned above.

- 3. Uplift Testing:** SunSky corrugated polycarbonate panels meet Uplift Test Criteria specified in UL 580 Test for Uplift Resistance of Roof Assemblies (UL Class 90). (Consult Palram Americas technical support for additional details if necessary.)

**Test Description**

**Roof Covering:** Corrugated polycarbonate roof panels with 9 inch spaced corrugations. The tested material comes in 0.032" thick x 38" width and 12 feet long.

**Fastener:** #12 - 14 x 1 1/4" Type 2 Structural Drilling Fastener, carbon steel, zinc plate with 3/4" O. D. heavy EPDM/galvanized washer.

**Uplift Test Results**

A buckled hip was visible during the test. The fasteners were in place and no cracks or breaks were found in the SunSky panels. The test assembly withstood all phase of test for Class 90. The roof assembly described in this report met the uplift test criteria specified in UL 580 - Test for Uplift Resistance of Roof Assemblies. **Note:** The buckled hip returned to the original shape after testing with no panel damage or permanent deformation.

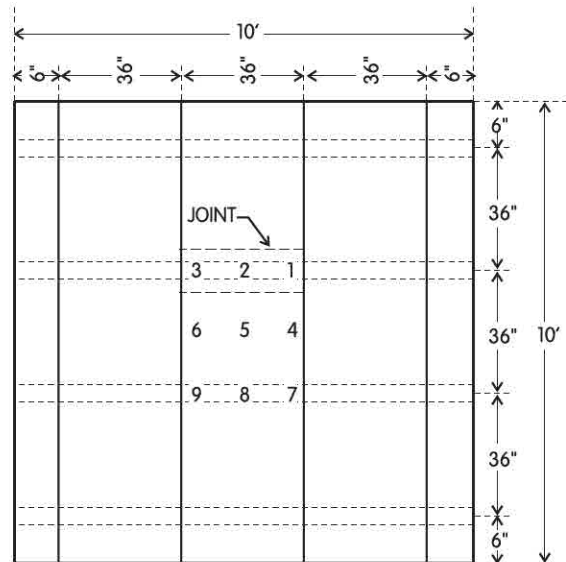

Figure 9

- 4. Purlin & Girt Spacing:** Purlin and girt spacing are usually dictated by overall design and engineering calculations along which the whole structure is constructed. SunSky panels are installed at the same purlin/girt spacing as the rest of the metal panels in the structure (according to ICBO Evaluation Acceptance criteria, p. 3).

Verify that the installed SunSky panels will remain within the uniform load-supporting limits of deflection as observed by the Evaluation Acceptance tests (see the "Uniform Load" diagrams and "Uplift" paragraphs).

In case purlin/girt spacing of the metal-clad structure surpass the values depicted in the tables by a significant margin (especially in multi-panel runs), a secondary support system, based on data in the above mentioned tables, should be prepared for the SunSky skylight or side light.

When support spacing is marginally larger, on-site environmental conditions should be considered and acted upon.

## I. Maximum Recommended Loads

Panel Type	Panel Thickness		Span Between Supports			
	Inch	mm	2 feet	3 feet	4 feet	5 feet
Sunsky 9"	.031	0.8	50 psf	25 psf	10 psf	--
	.039	1.0	50 psf	30 psf	12.5 psf	--
	.047	1.2	50 psf	35 psf	15 psf	--

Sunsky 12"	.031	0.8	50 psf	50 psf	35 psf	20 psf
	.039	1.0	50 psf	50 psf	45 psf	25 psf
	.063	1.5	50 psf	50 psf	50 psf	35 psf

Sunsky Greca 3"	.031	0.8	50 psf	30 psf	10 psf	--
	.039	1.0	50 psf	35 psf	15 psf	--

Sunsky 7.2"	.031	0.8	50 psf	50 psf	50 psf	30 psf
	.039	1.0	50 psf	50 psf	50 psf	40 psf
	.063	1.5	50 psf	50 psf	50 psf	50 psf

- The dimensions specified do not supersede the requirements of local construction codes.
- The maximum recommended loads are based on continuous beam setting, according to allowed deflection of 1/20 of the span, and valid for mid span only.
- The mentioned load refers to both wind and snow loads and intended for roof lights/wall lights only.

## J. Installation Comments (Roofing & Siding):

- 1. Single Panel Run Installation:** The length (long side) outermost crests of a SunSky panel should lap over matching adjacent crests of metal panels on both sides.
- 2. Multi-Panel Run Installation:** The middle SunSky panels should be installed with the regular under/over length overlap (the short crest edge on top of a longer one). The outermost SunSky panels on both length sides will lap over the adjacent matching metal panels, as in a single panel run, unless designed otherwise.

**Important!** Whenever the extreme side-laps of a Sky Light or Side Light side-laps are installed on top of the adjoining metal panels, the overlapping metal panel(s) above the opening should also be installed the same.

- 3. Framed Independent Side Light Installation:** An installation method for Side Lights, requiring framing for the apertures in the siding. Frame details enable installation of any SunSky profile, independent of the surrounding wall cladding.

Aluminum profile framing is very suitable, relatively inexpensive, and available in a wide variety of shapes, and is easy to work with (Custom shapes are available with minimum quantity requirements).

Fabricated zinc plated, painted or stainless steel sheet are possible options, moderately priced and easy to fabricate. Wood framing is also possible, especially for small-scale and DIY jobs. Typically, the designs of these structures are more simple to build, and requires only basic everyday tools.

- 4. Side-lap Support:** At side-laps where the SunSky edge corrugation has to be installed under the corrugation of the adjoining metal panel, or in SunSky on SunSky side-laps (multi-panel runs) length support profiles, of metal or wood, are recommended. Such length supports ensures better side seal and rigid installation. (See Fig. 20, 34)

Support details should suit the Sunsky profile used.

### SunSky Sky Lights in roofing:

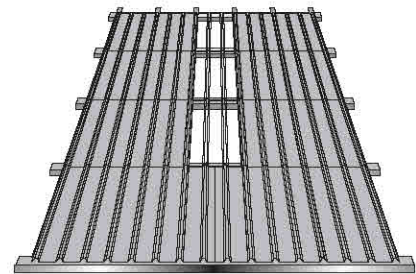

Single panel run  
 Figure 10



Multi panel run  
 Figure 11

### SunSky Side Lights in siding:

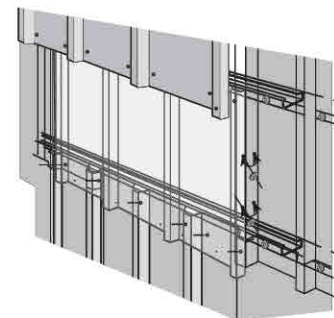

Single-span, single-panel  
 Side Light depiction  
 Figure 12

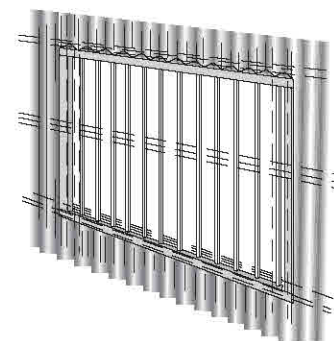

Multi-span, multi-panel  
 framed Side Light  
 Figure 13

## K. Fastening & Sealing:

- Following recommendations:** Use of recommended fasteners and washers, along with careful execution according to the installation instructions is essential for maximum product performance.
- Graphic depiction of SunSky Fasteners Positioning at Side-Laps, Supports & End-Laps:**

**SunSky 12"** Figure 14a

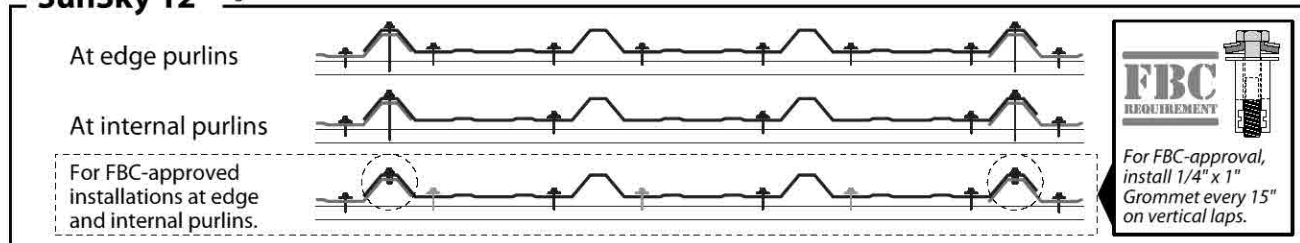

**SunSky 9"** Figure 14b

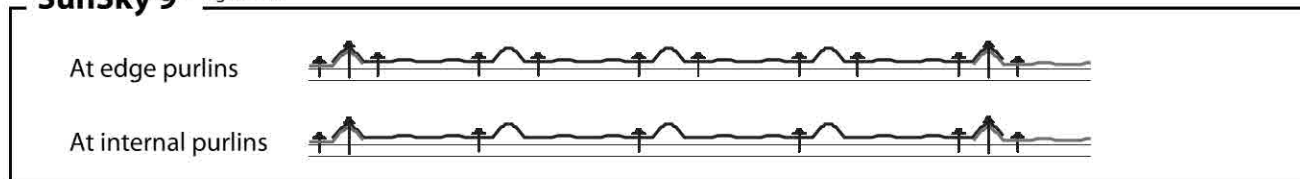

**SunSky 3"** Figure 14c

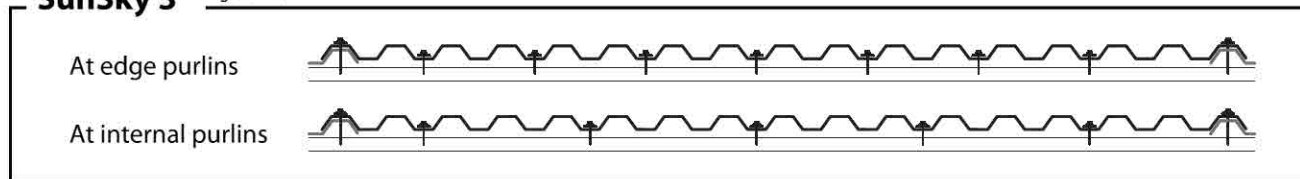

**SunSky 7.2"** Figure 14d

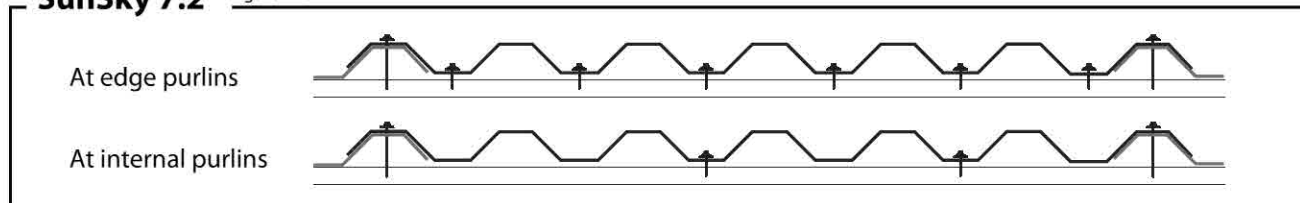

### 3. Recommended Washers & Fasteners:

**Metal structures:** Self-Drilling Tapping Screw

**Wood structures:** Tapping Screw

**Side Stitching:** Sharp Point Self-Tapping Screw

**Washer:** Palram metal washer with EPDM gasket (see figure 15a, 15b, and 15c;

15c required for FBC-approved installations)

**Grommet:** Expanding rubber fastener

(see fig. 15d & 16b; required for FBC-approved installations)

**Palram Metal Washers w/Concave EPDM Gasket**

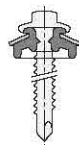

3/4" (19 mm)  
Washer/gasket  
Figure 15a

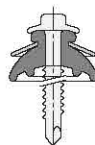

1" (25 mm)  
Washer/gasket  
Figure 15b

**Metal Washer w/EPDM Gasket**



#12-14 x 1-1/4" HWH w/1-1/8"  
Oversize Bonded Washer  
(pre-drilling w/oversize holes required)  
Figure 15c



**Grommet Fastener**

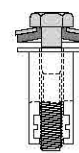

1/4" x 1" Grommet  
(pre-drilling required)  
Figure 15d

### Suggested Fastener Types and Placement Table 4

	SunSky 9"	SunSky 12"	SunSky Greca 3"	SunSky Greca 7.2"
<b>Fastening at crown</b>	1/4" x 2" with 3/4" washer	1/4" x 3" with 1" washer	1/4" x 2" with 3/4" washer	1/4" x 3" with 1" washer
<b>Fastening at valley</b>	1/4" x 1-1/2" with 1" washer	1/4" x 1-1/2" with 1" washer	1/4" x 1" with 3/4" washer	1/4" x 1-1/2" with 1" washer

**Stitch Screw**

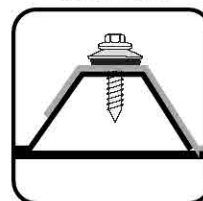

Figure 16a

**Grommet**

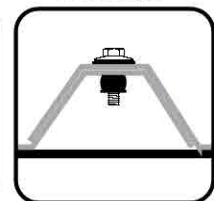

Figure 16b

#### 4. Palram Washer/Gasket Combinations:

- a. **Small Washer** - 3/4" (19mm) Special Bonded Washer/ Gasket (BWG)- conical metal washer (zinc-plated/ aluminum/ stainless steel), with bonded shaped EPDM gasket (see Figure 15a). As a general rule, 3/4" washers are installed on the corrugation crest fastening points.
- b. **Large Washer** - 1" (25mm) Special Combined Washer/ Gasket (CWG)- conical metal washer (zinc-plated/ aluminum/ stainless steel), with attached dome-shaped, contoured EPDM gasket (see Figure 15b). As a general rule, 1" washers are installed at the valley fastening points. 1" (25mm) washer/gasket combinations fasteners are especially recommended for panel lengths in excess of 12'. Additional oversize pre-drilling is also recommended in this case to accommodate additional expansion and contraction of the longer panels.

**IMPORTANT NOTE!** Palram Washer/Gaskets were chosen after comprehensive performance testing. The "umbrella" shaped gaskets seal the fastener holes & heads well without exerting excessive pressure on the SunSky panel itself. Limited thermal expansion is possible and compatibility with polycarbonate assured. **Regular Washer/Gaskets Fasteners (e.g. Tek Screws) for metal panels are NOT RECOMMENDED for use with SUNSKY as these types of washers apply excessive pressure, are inadequate for SunSky sealing, and cause undue internal stresses in the panel. The stresses result in crazing, fractures, and eventual failure. Installations using such fasteners are strongly discouraged and are subject to nullification of warranty.**

#### 5. Installation & Fastening Tips:

- a. **Allow for expansion & contraction at fasteners:** For panels longer than 12', pre-drill panels at all fastening points with a 3/8" hole to allow for increased expansion and contraction due to longer length. For panels 12' in length or less, pre-drill a hole 1/16" larger than the diameter of the fastener shank. Palram recommends that SunSky panels are not installed below 40°F or above 80°F. See Page 19, Figure 39, for a detailed SunSky Thermal Expansion Table.
- b. **Drive fasteners perpendicular to SunSky face.** Use an adjustable-torque power screwdriver to ensure against overtightening. Avoid distortion of washer/gasket and panel. (See fastener positioning details - Figure 17a and 17b). **Never use an impact wrench/driver for fastening SunSky.**
- c. **Installation Direction:** We recommend starting installation from the bottom up, on one side, and work to the left or right accordingly. **Never start working from both ends to the middle.** Always lap the top panel over the lower one.
- d. **Keep panel straight, flush and taut during installation.**
- e. **Do not overtighten** (see "Important Not above and Figure 17)
- f. **Side-Lap Support:** At a side-lap of metal on SunSky or two SunSky panels (multi-panel installation) a lengthwise wood or steel support bar may be required.
- g. **Fastening Details** (Schematic Figures 18, 19, 20, and 21):
  1. SunSky panel
  2. Adjoining metal panel
  3. Valley fastener, with 1" Washer
  4. Metal crest/ valley fastener
  5. Side-lap fastener with 3/4" washer
  6. Side-lap stitching fastener and 3/4" washer
  7. Butyl-rubber or expanding sealing strip
  8. Optional side-lap support bar
- h. **Fasteners Positioning Comments:**
  - Generally valley fasteners should be installed at the top & bottom edges, and at end-laps of SunSky panels, as shown on Page 10, Section K, Figures 14a-14d.
  - In multi-panel runs, the number of fasteners can be reduced at mid-purlins, unless conditions demand otherwise. The remaining fasteners should be evenly positioned adjoining the main corrugations of the specific panel.
  - Stitching screws should be distributed 12"-16" apart.

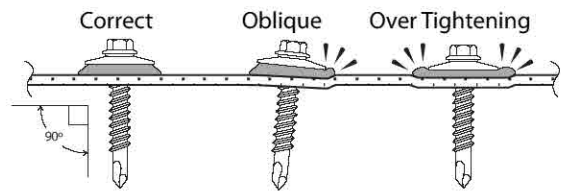

Right & wrong fastener insertion

Figure 17a

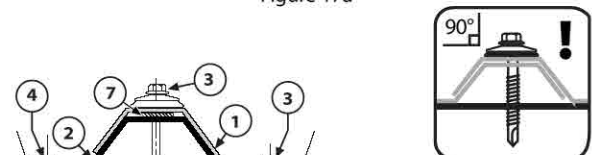

Figure 17b

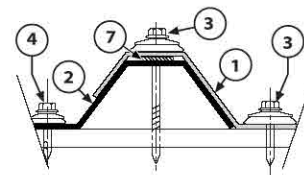

Figure 18

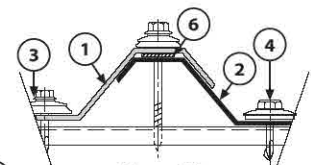

Figure 19

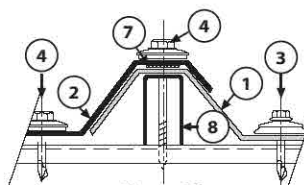

Figure 20

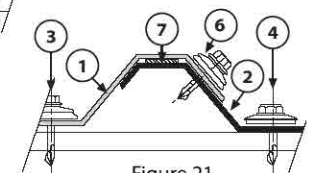
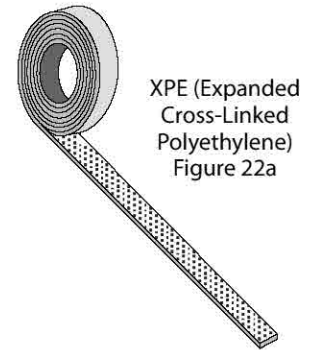

Figure 21

## 6. Sealing SunSky:

- a. Self-Adhesive XPE Sealing Tape (Expanded Cross-Linked Polyethylene):** Resilient, closed cells, self adhesive foamed-polyethylene, in long at strips, to be applied at sides & end-laps, on top of the overlapped area. Cross-section dimensions may vary according to specific requirements. A typical one is 3/4" (20.0 mm) width, 3/16" (5.0 mm) thickness and comes with pressure sensitive adhesive on one side, protected by silicone paper.



### Butyl-Rubber or Expanding Sealing Tape:

Elastomeric or Expanding Sealing Tape to be applied at side & end-laps, on top of the overlapped area. Do not use mastic tape.

**Install as follows:** (See Page 11, Figures 18-21 and Page 13, Figures 23-25)

Remove bottom protective paper strip progressively, as installation advances. Apply carefully by hand.

- **Single seal end-lap:** Apply along fasteners' center-line at the end-lap, following the profile shape.
- **Double seal end-lap:** Apply above and below fasteners' center-line at end-lap, following the profile shape.
- **Single seal side-lap:** Apply on top of center-line of side corrugations to be overlapped by metal or SunSky.
- **With butyl-rubber strips only:** Remove top protective paper strip before laying the overlapping panel. Lay the edge of lapping panel and apply moderate hand pressure on the top panel along the side corrugation, to assure good fitting and/or even seal/bond.

## b. Top & Bottom Contoured End Closures:

Top or bottom matching closure strips close the clearance above or below the panel and its corrugations.

### Install as follows:

Place the closure strip at the top or bottom edge fasteners' center-line, and insert the fasteners through said strip so it will be held firmly in place. A few dabs of silicone could hold the strip temporarily in place until the top panel is laid and screws are inserted. (Figures 26a, b, 27a, b, 30)

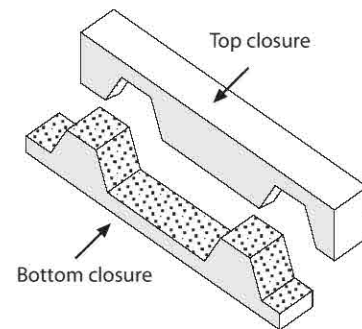

Top & Bottom End Closures  
(SunSky 12")  
Figure 22b

- **Location A:** Where SunSky runs reach the top or bottom of roof or wall edges, or at the roof ridge, the space left between the panel's profile and the purlin, or girt, should be closed and sealed with a contoured foam, polyethylene (XPE) closure strip matching the panel profile.
- **Location B:** Where SunSky runs reach a top trim, or at a ridge-cap, a top closure strip should be used at the top edge above the panel.
- **Alternative option:** Contoured-end closure may also be made of wood, when it's worthwhile.

## c. Silicone Sealants:

**Unapproved sealants, adhesives or bonding materials may be found ineffectual and incompatible, and can chemically attack the panels, originate failure, and revoke any and all warranties.**

- Palram strongly recommends the use of 100% silicone sealant.
- Contact Palram Americas for a complete list of tested and approved sealants, and other tested and approved sealing, bonding and adhesives materials that may be required.
- Other silicone sealants or other sealing, bonding or adhesives materials should be submitted to Palram Americas or its distributor for evaluation and approval before use.



## L. Side & End Lap Installation:

End lap (or width overlap - short side) of a SunSky panel on another consecutive SunSky or metal R-panel, should always be done over a supporting purlin. Each of the panels involved should overhang the purlin center-line by about 3" (2" min. and 4" max.), totaling an average overlap of 6".

### Fastener and Sealing Tape Locations

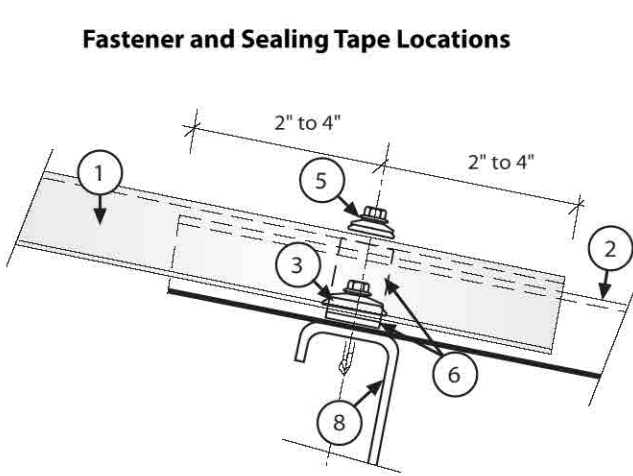

End-Lap Detail  
 Figure 23

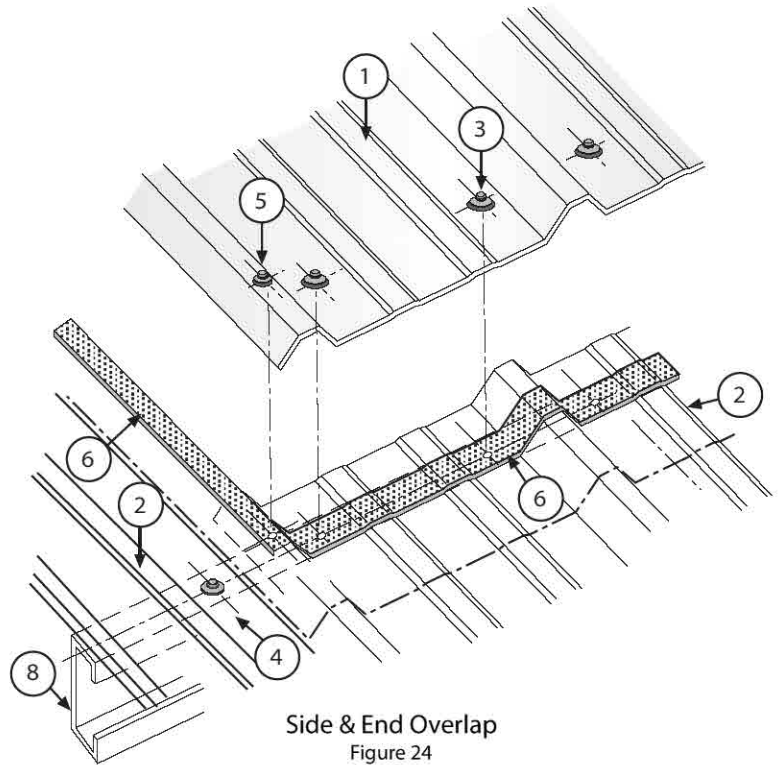

Side & End Overlap  
 Figure 24

### Legend

- ① 12" SunSky panel
- ② Metal R-panel
- ③ SunSky valley fastener, with Palram 1" special washer gasket
- ④ Typical sheet-metal crest or valley fastener with 3/4" washer and gasket
- ⑤ SunSky crest (side-lap) fastener with Palram 3/4" special washer & gasket
- ⑥ Sealing tape installed along side & end lap corrugations
- ⑦ Shaped bottom-end closure
- ⑧ Supporting purlin
- ⑨ Option Drainage Gutter

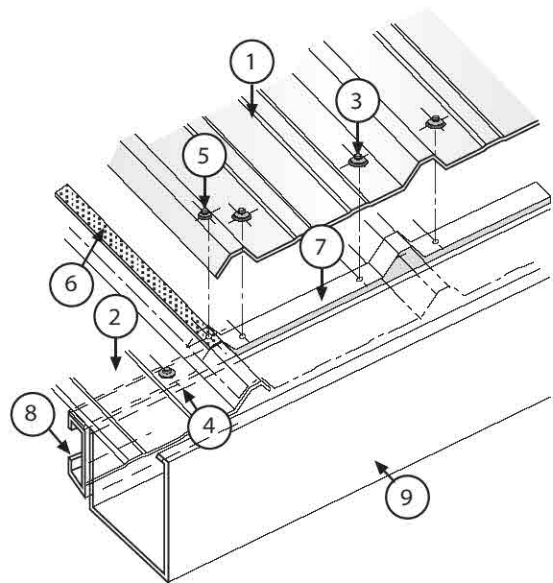

Bottom Edge SunSky Installation  
 with Profiled Closure Strip  
 Figure 25

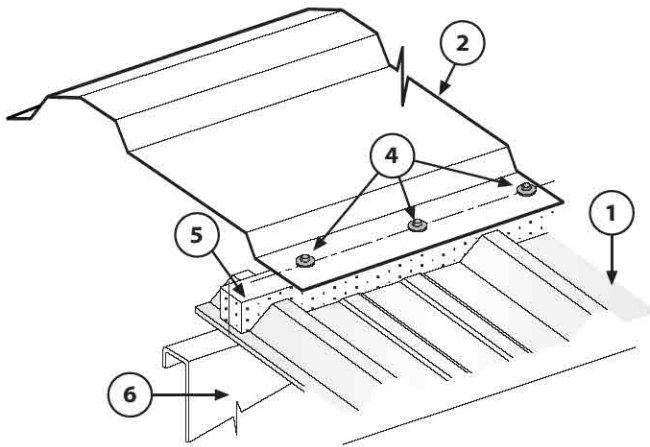

SunSky Ridge Cap Fastening  
Figure 26a

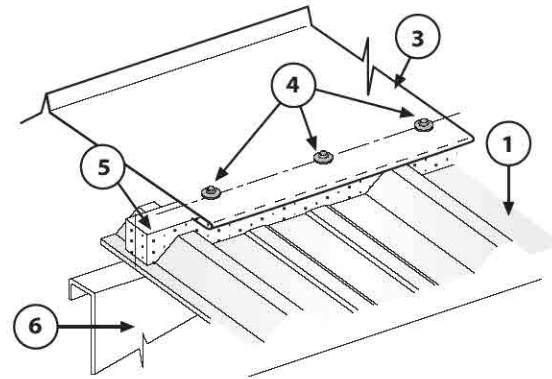

Sheet-Metal  
Ridge Cap Fastening  
Figure 27a

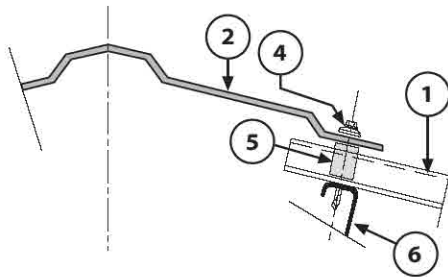

SunSky Ridge Cap Fastening  
& Top Partial Section  
Figure 26b

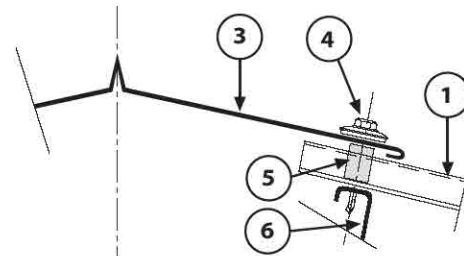

Sheet-Metal Ridge Cap Fastening  
& Top Partial Section  
Figure 27b

**Legend**

- ① 12" SunSky panel
- ② SunSky Universal Ridge Cap
- ③ Sheet-metal universal ridge cap (typical)
- ④ Crest fastener (side-lap) with Palram 3/4" special washer & gasket
- ⑤ Shaped Foam Closure (fits topside of panel)
- ⑥ Supporting purlin

**Important notes about installation of SunSky Ridge Caps**

1. Do not over tighten screws when installing. If ridge cap deforms, screws are too tight.
2. Use recommended fasteners as stated in Table 4 (page 10).
3. When installing clear ridge caps on wood purlins, purlins should be painted with white acrylic-based paint prior to installation. This will help prevent overheating and possible charring of the purlins.

## M. Options for Installation:

**1. Single width, single span installation**  
(on 2 edge support purlins), integrated and surrounded by matching metal panels, overlapped on top, overlapping and supported on both sides and at the bottom. This dictates that the top metal panel is also installed with its edge corrugations overlapping at both sides, up to the roof edge or ridge.

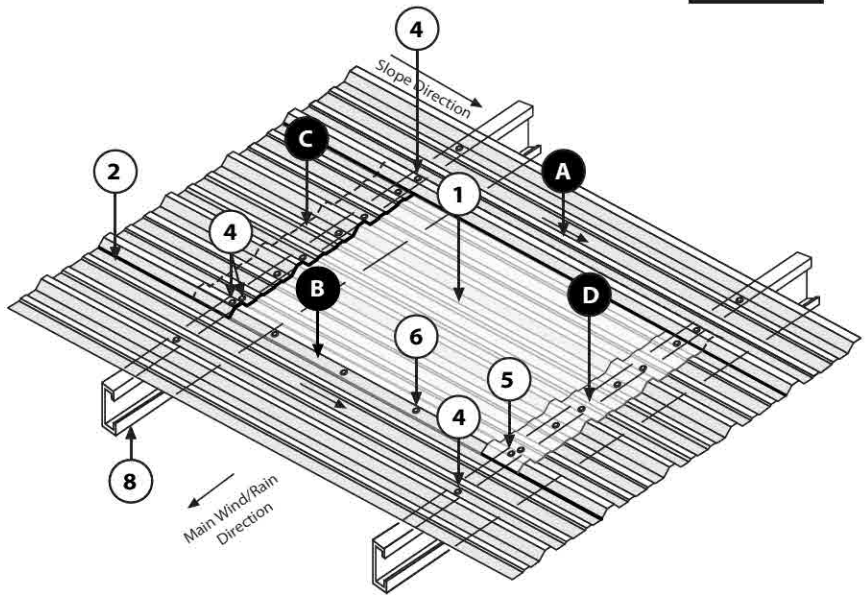

Typical, Single Panel, Single Span Mid-Field Detail

Figure 28

### LEGEND

#### Connections

- A** Right side-lap: metal R-panel overlaps 12" SunSky panel
- B** Left side-lap: 12" SunSky panel overlaps metal R-panel
- C** Top end-lap: top metal R-panel laps over top edge of SunSky panel
- D** Bottom end-lap: bottom edge of SunSky panel laps over top edge of metal R-panel
- E** Bottom edge detail: SunSky panel at the bottom edge of a roof, with or without a gutter

#### Components

- ① 12" SunSky panel
- ② Metal R-panel
- ③ SunSky valley fastener, with Palram 1" special washer gasket
- ④ Typical sheet-metal crest or valley fastener with 3/4" washer & gasket
- ⑤ SunSky crest (side-lap) fastener with Palram 3/4" special washer & gasket
- ⑥ SunSky side-lap stitching fastener
- ⑦ Foam closure (underside shape)
- ⑧ Supporting purlin
- ⑨ Main supporting truss / beam
- ⑩ Optional collecting gutter

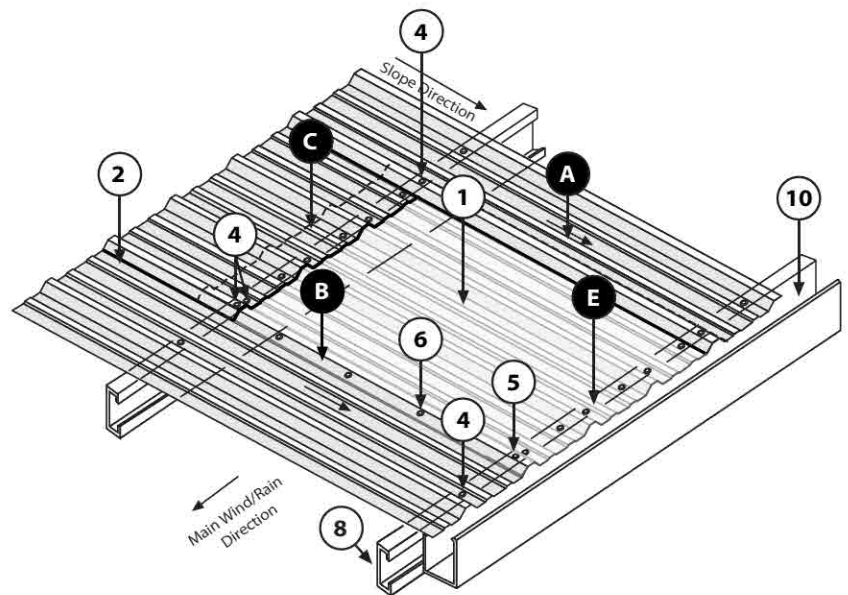

Typical Bottom End SunSky Detail (with or without gutter)

Figure 29

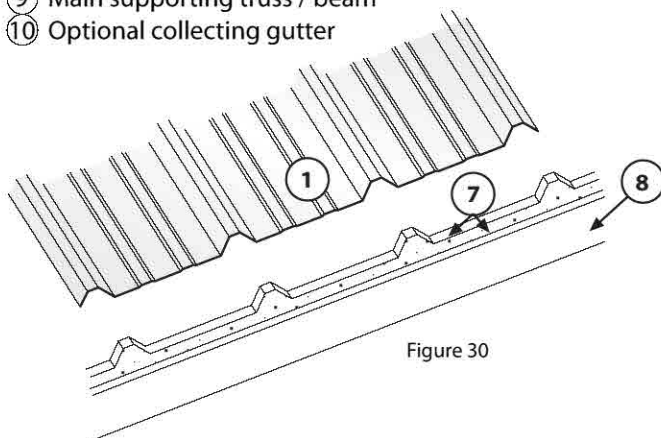

Figure 30

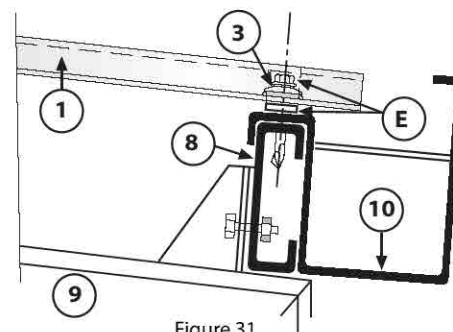

Figure 31

**2. Single width, multi-span installation**, on a few support purlins, using one single long panel or a few consecutive ones, overlapping each other (See Single-Panel Runs, page 9, fig. 10).

This option can be implemented by two possible alternatives:

- Installed mid-field, surrounded by matching metal panels, overlapped on top, overlapping both sides & bottom.
- Installed from top to bottom or from ridge to bottom (one or two way pitched roof). This alternative enables the use of SunSky panels on metal roofs with profiles that don't exactly match.

Both alternatives allow SunSky panels installation on top of outermost length corrugations of metal panels on both sides, for tougher, stiffer installation with better sealing, enabling easy installation of the SunSky skylight panels after the metal roofing is already in place (proper clearance must be provided for).

**3. A multi-width, multi-span installation** (See Multi-Panel Runs, page 9, fig. 11).

This can be implemented the same way as the two alternatives mentioned above, either as an integrated part of a roof plane, or as an independent roof, its edges overlapping the metal panels on its two sides.

**4.** When installing SunSky on glass fiber mats insulated steel roof, be sure to use a suitable spacer along the purlins and avoid any contact between the vinyl finish of the mats and the SunSky panels (fig. 32, 33).

- 12" SunSky single / single-run / multi-run skylight panel, overlapping lengthwise on both sides
- Typical metal R-panel installed on all sides
- SunSky valley fastener, with Palram 1" special washer & attached EPDM conical washer
- Typical sheet-metal crest or valley fastener with 3/4" washer & gasket
- SunSky crest (side-lap) fastener with Palram 3/4" special washer & gasket
- SunSky side-lap stitching fastener
- Butyl- rubber sealing strip installed along width & length end corrugations at all overlap.
- Height equalizing shim - wood or rigid plastic bar of suitable thickness compensating for the thickness of the insulation mat at the purlins
- Supporting steel purlin
- Main supporting structure
- Galvanized sheet-metal strip for insulation mat support
- Glassfiber or rockwool insulation mat underneath the steel roofing with reinforced aluminum foil or vinyl film bottom finish, supported by the metal strips

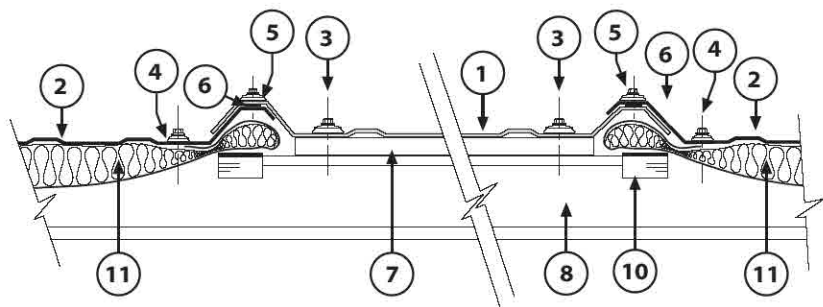

Width Cross-Section Detail  
Figure 32

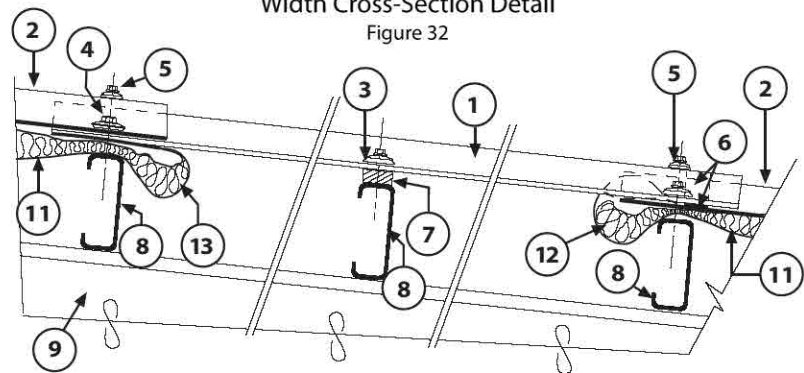

Length Section Detail  
Figure 33

- End of insulation mat at the lower edge of the skylight with the mat edge tucked back and under metal to create a nice edge finish
- Same as 13 but at the upper edge of the skylight, and at vertical edges. **Caution:** The vinyl used on insulation make be incompatible with SunSky. Insert a separate layer between the SunSky sheet and the tucked-back vinyl-covered insulation to prevent potential outgassing damage to the SunSky panel.

**5. Installing SunSky Side Lights on Exterior Walls:**

When installing, fastening and sealing side lights, follow the same general procedures for roof installation as described on the preceding pages.

Certain installation methods are specific to siding installation, like the framed Side Light.

**Typical Side Light Applications:**

- A** Multi-panel, single-span
- B** Single-panel, multi-span
- C** Multi-panel, multi-span
- D** Single-panel, single-span (Figures 12)
- E** Framed Side Light (Independent of surrounding cladding type)

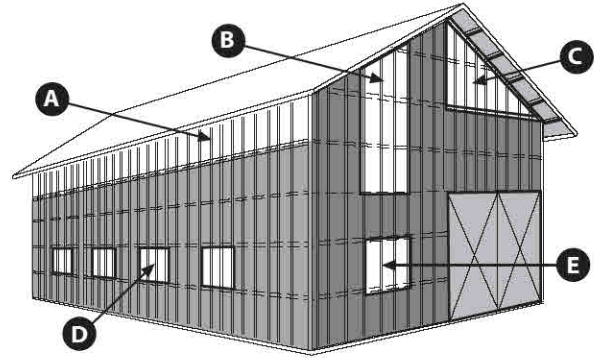

Typical Side Light Applications

Figure 34

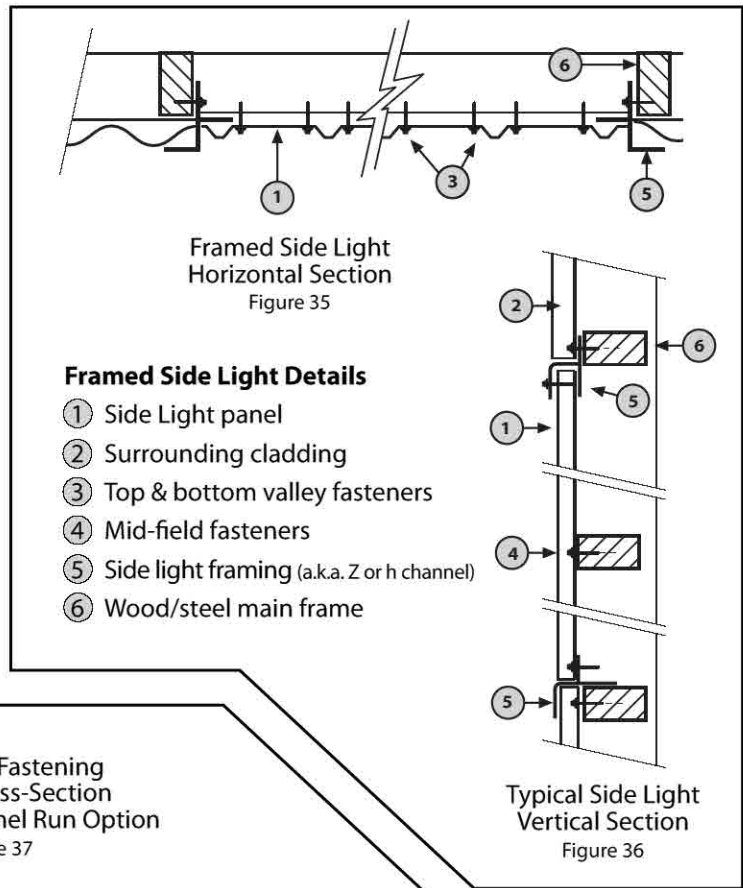

Framed Side Light Horizontal Section

Figure 35

**Framed Side Light Details**

- ① Side Light panel
- ② Surrounding cladding
- ③ Top & bottom valley fasteners
- ④ Mid-field fasteners
- ⑤ Side light framing (a.k.a. Z or h channel)
- ⑥ Wood/steel main frame

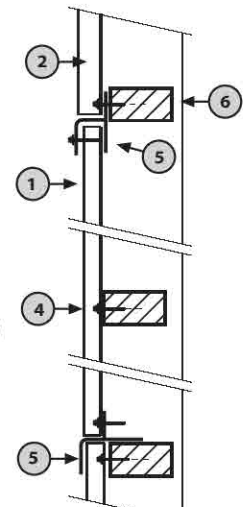

Typical Side Light Vertical Section

Figure 36

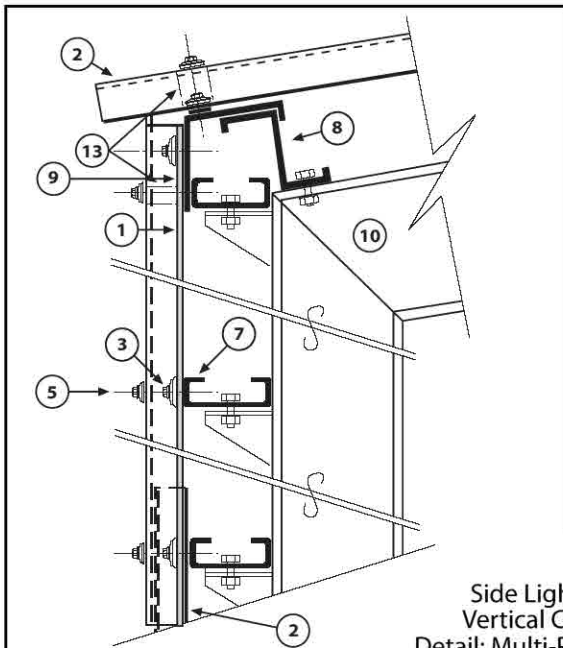

Side Light Fastening Vertical Cross-Section Detail: Multi-Panel Run Option

Figure 37

**Integrated Side Light Details**

- ① 12" SunSky side light panel
- ② Metal panel
- ③ SunSky valley fastener
- ④ Sheet-metal fastener
- ⑤ SunSky crest fastener
- ⑥ Side lite metal or wood length support
- ⑦ Wall girt
- ⑧ Roof-edge Z purlin
- ⑨ Eave-strut
- ⑩ Main supporting frame
- ⑪ Structural corner profile
- ⑫ Sheet-metal corner trim
- ⑬ Shaped foam closure (underside shape)

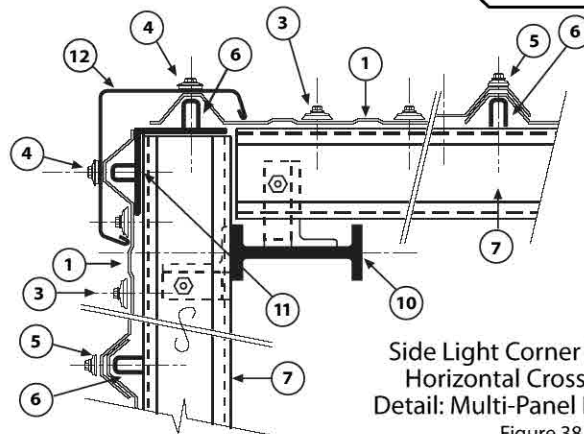

Side Light Corner Fastening Horizontal Cross-Section Detail: Multi-Panel Run Option

Figure 38

## N. Important Installation Comments:

- 1. Avoid overtightening the fasteners.** Allow gaskets to squeeze slightly until full contact with panel. Overtightening induces undue internal stresses, leading to premature failure.  
**Regular Washer/ Gaskets (Tek Screws) for metal panels apply excessive pressure, are inadequate for SunSky sealing, and cause undue internal stresses in the panel. The stresses result in crazing, fractures, and eventual failure.**
- 2. Never use** soft PVC (vinyl) washer/gaskets. Soft PVC is totally incompatible to polycarbonate and will harm the panel.
- 3. Never apply** paints, shading compounds, paint thinners or any material that may chemically attack SunSky, without first verifying compatibility to the panel by contacting Palram Americas or its distributor.
- 4. Always work safely.** Follow safety recommendations in the Installation Instructions.
- 5. Maximum span:** Net spans should not exceed 5' to avoid thermal expansion buckling. In areas where there are significant snow loads, spans should not exceed 3'. Follow recommendations on page 7.
- 6. Fastening:** Always use recommended fasteners for securing Sunsky. Never install SunSky by nailing.
- 7. Isolating SunSky from harm:** When placing SunSky on asphalt shingles, soft PVC or vinyl, or other incompatible materials, use an isolating barrier, metal or wooden strips, EPDM rubber patch etc., between the panel and a doubtful material.
- 8. Extra Fastening:** On length runs, where SunSky overlaps metal panels on both sides, we recommend side stitching fasteners beside the main fasteners connecting the SunSky to the frame. These should be spaced along the side-laps about 12-16" apart.
- 9. End-Lap Support:** SunSky/metal or SunSky/SunSky panel end-lap should always be fully supported, to avoid deflection at that area. This also applies to ridge-cap/SunSky end-lap.
- 10. Support Profiles:** At SunSky/SunSky or metal/SunSky side-lap (length overlap), metal or wood length support bars can be added under the side-lap to minimize deflection, assisting in sealing & stitching. The length support bars should be sized to suit the corrugations.
- 11. Silicone Sealant:** 100% silicone sealant (*see page 12, section 6c*). Refer to Palram Americas or its distributor for other approved sealing or bonding materials should they be required. **Unapproved sealing or bonding material may be incompatible, damage the panels, cause failure and void warranty.**
- 12. Butyl-Rubber Seals:** Side-laps and End-laps of any SunSky profile should be treated with butyl-rubber or expanding tape, placed between the overlapping panels at all edges. In shallow pitch roofs (less than 5 percent) double (parallel) sealing strips are recommended at end-laps.
- 13. Shaped Foam Closures:** Expanded foam polyethylene (XPE) closure strips are used to seal the space between the upper or lower SunSky profile to edge purlins or ridge caps. Matching XPE top & bottom strips are available for each major SunSky profile. The strip is held in place by the screws fixing the panel to the purlin. (see figures 26a,b, 27a,b, 30).
- 14. When installing clear SunSky,** it is advisable to paint purlins using white acrylic paint, or to cover with aluminum tape, in order to prevent over-heating and/or charring of the purlins.



**14. Cleaning:** Most normal dirt & dust accumulation is washed off by periodic rains. Regular hosing of the panels with clean lukewarm water is sufficient in dry areas.

In polluted, oily environments, mild household detergent may be used, assisted by a soft rag or soft-bristled brush. **Never use aggressive or abrasive cleaning agents or glass window cleaners.** They may scratch or chemically attack the panel. Large areas-could be washed by high-pressure water-jet, optionally, in conjunction with diluted detergent. Dry with soft cotton rags to avoid spotting.

**15. Repair:** Minor damages to the panel may be repaired. Small punctures can be stopped by dabs of approved silicone sealant. Larger tears may be patched by pieces of matching panel, bonded & sealed on top of the tear with compatible structural silicone.

**16. Study and Preparation:** Prior to actual installation study the SunSky Installation Guide carefully. Make sure all the instructions are understood and all required materials, accessories and tools are available.

**17. Information:** Please contact Palram or its distributor regarding any applications, requests and inquiries you may have before starting installation.

**18. Accessories Information & Supply:**

Palram Americas and its distributors will assist, advise and supply, upon request, various additional accessories that may be required for appropriate installation, such as butyl-rubber or expanding sealing tape, special fasteners and washer/gaskets, etc.

**O. Thermal Expansion Table for SunSky Corrugated Polycarbonate**

Palram recommends that Sunsky panels are not installed below 40F or above 80F. See Page 11, Section 5a, for important notes about pre-drilling panels with oversize holes to accommodate expansion and contraction of panels.

(Figure 39)

Panel Length		$\Delta L$ (Inches) where $\Delta T =$				
Ft	Inches	20°F	40°F	60°F	80°F	100°F
8	96	0.071	0.142	0.213	0.284	0.355
10	120	0.089	0.178	0.266	0.355	0.444
12	144	0.107	0.213	0.320	0.426	0.533
16	192	0.142	0.284	0.426	0.568	0.710
24	288	0.213	0.426	0.639	0.852	1.066

Inasmuch as Palram Americas has no control over the use to which others may put the product, it does not guarantee that the same results as those described herein will be obtained. Each user of the product should make his own tests to determine the product's suitability for his own particular use including the suitability of environmental conditions for the product. Statements concerning possible or suggested uses of the products described herein are not to be construed as constituting a license under any Palram Americas patent covering such use or as recommendations for use of such products in the infringement of any patent. Palram Americas or its distributors cannot be held responsible for any losses incurred through incorrect installation of the product. In accordance with our company policy of continual product development you are advised to check with your local Palram Americas supplier to ensure that you have obtained the most up to date information.

**Palram Americas** reserves the right to change product specifications and/or information contained in this brochure without notice.



**PALRAM AMERICAS**

9735 Commerce Circle, Kutztown, PA 19530  
Phone: 610-285-9918 (Toll Free: 800-999-9459)  
Fax: 610-285-9928  
E-mail: [PalramAmericas@palram.com](mailto:PalramAmericas@palram.com)  
Web Site: [www.PalramAmericas.com](http://www.PalramAmericas.com)





# POLYCARBONATE SHEET

Care and Maintenance

[PAGE 1 OF 2]

This document covers the care and maintenance of the following polycarbonate sheet products:

PALSUN®  
PALSUN® CS  
PALSUN® SG  
PALGARD™  
PALGARD™ TG  
PALSHIELD™  
SUNTUF®  
SUNSKY®  
DYNAGLAS®  
SUNTOP®  
SUNLITE®  
THERMAGLAS™

## Palram Americas, Inc.

ISO 9001:2000 | ISO 14001-2004 Certified

### Customer Service

9735 Commerce Cir., Kutztown, PA 19530  
Phone: 800-999-9459, +1-610-285-9918  
Fax: +1-610-285-9928  
E-Mail: sales.usa@palram.com

### Technical Service

Phone: 800-999-9459 Ext. 292  
Fax: +1-610-285-9928

[www.palramamericas.com](http://www.palramamericas.com)

## General Polycarbonate Cleaning Guidelines

- Never use abrasive or high alkaline cleaners on any Palram polycarbonate products
- Do not leave cleaners on Palram polycarbonate for extended periods of time. Rinse immediately with cold, clean water.
- Do not apply cleaners in direct sunlight.
- Never use sharp objects, squeegees or razors on polycarbonate.
- Do not clean with gasoline.
- Always practice safety first and never step directly on a polycarbonate panel.
- Always test cleaners in a small inconspicuous area prior to cleaning entire panel to insure against adverse results.
- Avoid allowing the pressure washer spray tip to come too close to the panel. Pressure washers often have enough pressure at the spray tip to penetrate or tear the panel.
- Avoid dry cleaning, as sand and dust particles clinging to the exterior of the panels may scratch the surface.
- Avoid cleaning the interior surface of DYNAGLAS and THERMAGLAS, as the effectiveness of the anti-condensate coating can potentially be diminished, depending on cleaning method or material used.

## General Cleaning Instructions for all Products Listed at Left

All of the Palram polycarbonate products listed at left can be easily cleaned utilizing a soft sponge or cloth made from 100% cotton using lukewarm water and a mild dishwashing detergent. All surfaces should then be rinsed with cold water and dried with soft cotton cloth to reduce water spotting. In some instances this procedure may be inadequate and will require the use of additional cleaning agents. The agents listed below have all been approved for use at room temperature:

- Methyl alcohol
- Ethyl alcohol
- Butyl alcohol
- Isopropyl alcohol
- Heptane
- Hexane
- Petroleum ether (BP 65°)
- VM&P Naphtha

As is the case with all thermoplastic materials, certain chemicals can cause structural as well as surface damage and precautions need to be taken to avoid any aggressive cleaning agents. Should you desire to use a cleaning agent not on the approved list, please contact a Palram representative to inquire about our in-house chemical compatibility testing capabilities.

## Specific cleaning instructions for large roofing and wall applications

Palram polycarbonate products used for large commercial roofing and wall applications (SUNTUF, DYNAGLAS, SUNSKY, SUNTOP, SUNLITE, THERMAGLAS) can be cleaned in the same fashion as mentioned previously; sometimes, due to the sheets physical installation location, different cleaning apparatus need to be utilized. When polycarbonate products are installed in such applications, utilization of a pressure

*(continued next page)*





# POLYCARBONATE FLAT SHEET

Care and Maintenance (*continued*)

[PAGE 2 OF 2]

This document covers the care and maintenance of the following polycarbonate sheet products:

PALSUN®  
PALSUN® CS  
PALSUN® SG  
PALGARD™  
PALGARD™ TG  
PALSHIELD™  
SUNTUF®  
SUNSKY®  
DYNAGLAS®  
SUNTOP®  
SUNLITE®  
THERMAGLAS™

washer with a fanned nozzle and mild detergent can assist in removing dirt buildup, algae and mold from the panels. This also eliminates the need to step directly on panels while attempting to clean unreachable areas.

Another method of cleaning large structures requires the use of a long-poled, car or RV washing pad. First, soak the panels with a mild soap and water solution, then proceed to scrub the panels with the car washing pad. Finish with a clean, cold water rinse.

### **Graffiti Removal on PALGARD / PALGARD TG / PALSHIELD**

⚠ *Recommended for these three products only; not recommended for any other products at left.*

The abrasion resistant surface of PALGARD / PALGARD TG and PALSHIELD sheets provide increased protection against chemical attack. Even graffiti, such as spray paint are easily and quickly removed. Although the above sheets have a abrasion resistant coating, the use of abrasive cleaners and/or sharp cleaning instruments that may damage or scratch the coating should be avoided. The recommended cleaning procedure for the removal of graffiti etc. is as follows:

1. For removal of paints, marking pen inks, lipstick, etc., the use Butyl Cellosolve or Isopropyl Alcohol is generally effective. The use of masking tape, adhesive tape or lint removal tools works well for lifting off old weathered paints.
2. To remove labels, stickers, etc., the use of VM&P Naphtha or Isopropyl Alcohol is generally effective. If the solvent will not penetrate sticker material, apply heat (hair dryer) to soften the adhesive and promote removal.
3. As a final step, wash with warm soap solution, followed by a rinse with clean water.



# SUNSKY®

## Manufacturer's Limited Warranty

### 1. SCOPE OF WARRANTY

- A. It is hereby warranted by Palram Americas (hereinafter "the manufacturer", subject to any other terms contained herein, that for a period of ten (10) years from the commencement date, as defined below, SunSky®, (hereinafter "the product") shall not lose more than 10% of its light-transmitting capability, as a direct and exclusive result of the impact of solar radiation (as measured pursuant to the procedures specified in ASTM D1003-77). (Loss of above capability, in excess of 10% shall be hereinafter referred to as a "decrease").
- B. It is hereby warranted by the manufacturer, that for a period of ten (10) years from the commencement date, as hereunder defined, the product shall not break as a direct and exclusive result of impact of hail measuring up to 1 inch in diameter in size, and attaining up to 20 meter/sec. in velocity (hereinafter referred to as "breakage").

### 2. COMMENCEMENT DATE

The commencement date shall be the date of the product manufacture or - if such date does not appear on the product- the date the product was purchased from the manufacturer.

### 3. LIMITATIONS

This warranty shall be valid only if:

- A. The product is installed, stored, and maintained in accordance with manufacturer's written instructions, and/or is not used in any non-customary fashion. Such instructions include:
- placing the correct side of the sheet facing outward;
  - maintaining proper purlin distance;
  - avoiding contact with chemicals, paints, adhesives, cleansing agents or other incompatible materials;
  - using only EPDM washers, never P.V.C. washers when fastening sheets;
  - spacing screws properly and without overtightening;
  - maintaining proper roof pitch;
  - cutting, drilling and fastening, according to the instruction and diagrams in manufacturer's brochure;
  - curving according to manufacturer recommendations to proper distance and curve radius;
  - installation of the product using the "SunSky System" as outlined on page B-8;
- B. The product is not thermoformed and not otherwise adversely affected by connection, fastening or sealing;
- C. Where decrease is not due to product alteration or damage, directly or indirectly caused by fire, vandalism, structural defects at the site of installation, natural disasters, improper storage or installation (including, but not omitted to negligently transporting or installing the product). Further, this warranty does not apply to a decrease caused by the accumulation of dirt, lack of proper maintenance, scratches, chemicals, paint or any other similar factor.

### 4. CLAIMS

In case of a claim of product failure, the manufacturer must be notified by the end user within 30 (thirty) working days. Moreover, the manufacturer reserves the right to inspect any or all of the sheets involved and the installation site itself while the sheets are still in their original position and have not been removed or moved or altered in any way. Such inspection shall be conducted by the manufacturer' technical personnel or the manufacturer's designated representatives. In addition, the manufacturer reserves the right to investigate independently the circumstances of such failure, including checks with the local meteorological survey and others. The claimant shall provide the manufacturer immediately, upon request, with any samples of the product which the manufacturer shall demand.



## **SUNSKY® Manufacturer's Limited Warranty (continued)**

### **5. COMPENSATION**

- A. In the event manufacturer is duly notified of decrease within 5 (five) years of the commencement date, and a claim for such decrease is properly made and approved, manufacturer will provide free substitute product.
- B. In the event manufacturer is duly notified of decrease after more than 5 (five) years from the commencement date, and claim for such decrease is properly made and approved, prior to the expiration of 10 (ten) years from the commencement date, manufacturer will provide substitute product CIF U.S.A. port. The replacement price to be paid by the purchaser will be calculated by multiplying 1/120th of the then effective price of the product by the number of months which have passed from the commencement date until the time of the claim.
- C. In the case of verified product breakage, manufacturer will supply replacement sheets at a fraction of the current market value of the sheets. The replacement price to be paid by the purchaser will be calculated as follows: 1/120th of the then effective price of the product multiplied by the number of months which have passed from the commencement date until the time of damage.
- D. In all cases, the manufacturer shall have an option to pay the value of the claim instead of providing substitute product.

THE REMEDIES SET FORTH IN THIS WARRANTY CONSTITUTE THE SOLE AND EXCLUSIVE REMEDIES AVAILABLE TO PURCHASER AND, SAVE AS SET FORTH HEREIN, MANUFACTURER SHALL BE UNDER NO LIABILITY WITH RESPECT TO THE PRODUCT, INCLUDING, BUT NOT LIMITED, TO ANY COST AND/OR EXPENSE EXCEEDING ITS LIMITED OBLIGATIONS SET FORTH HEREIN. THE WARRANTIES SET FORTH HEREIN ARE EXPRESSLY IN LIEU OF OTHER WARRANTIES, EXPRESSED OR IMPLIED, WHETHER STATUTORY OF OTHERWISE, INCLUDING ANY IMPLIED WARRANTY OF MERCHANTABILITY OR FITNESS.

### **6. JURISDICTION**

This warranty is governed by and shall be construed according to the laws of the State of Pennsylvania, U.S.A. Any claim or dispute related to the product and/or this warranty shall be exclusively brought before the appropriate court in the State of Pennsylvania, U.S.A., which shall have the exclusive jurisdiction in any such claim or dispute.

### **7. LIABILITY**

PALRAM AMERICAS LIABILITY IS LIMITED, SOLELY AND EXCLUSIVELY TO THE PURCHASE PRICE OF THE PRODUCT AND IN NO EVENT SHALL PALRAM AMERICAS BE LIABLE FOR LABOR, INSTALLATION, FREIGHT, TAXES OR ANY OTHER CHARGES.

### **PALRAM AMERICAS**

Arcadia West Industrial Park • 9735 Commerce Circle • Kutztown, PA 19530  
(800) 999-9459 • <http://www.PalramAmericas.com>